

3GPP2 C.S0023-C

Version 2.0

Date: October 31, 2008



**3RD GENERATION
PARTNERSHIP
PROJECT 2
"3GPP2"**

Removable User Identity Module for Spread Spectrum Systems

COPYRIGHT

3GPP2 and its Organizational Partners claim copyright in this document and individual Organizational Partners may copyright and issue documents or standards publications in individual Organizational Partner's name based on this document. Requests for reproduction of this document should be directed to the 3GPP2 Secretariat at secretariat@3gpp2.org. Requests to reproduce individual Organizational Partner's documents should be directed to that Organizational Partner. See www.3gpp2.org for more information.

CONTENTS

1 GENERAL.....	1-1
1.1 Terms	1-1
2 Physical, Electrical, and Logical Interfaces	2-1
2.1 Physical Interface	2-1
2.2 Electrical Interface.....	2-2
2.3 Logical Interface	2-2
2.4 Security Features	2-2
2.4.1 2G Authentication and Key Generation Procedure	2-3
2.4.2 Algorithms and Processes	2-3
2.4.3 File Access Conditions.....	2-3
2.4.4 3G AKA (Authentication and Key Agreement) Procedure and Function	2-3
2.5 Function Description	2-4
2.6 Command Description.....	2-5
2.6.1 R-UIM Supply Voltage Identification	2-7
2.7 Content of EFs.....	2-8
2.8 Application Protocol	2-10
2.9 CDMA Card Application Toolkit.....	2-11
2.10 Coding of Alpha Fields in the R-UIM for UCS2.....	2-11
3 Multi-Mode R-UIM Dedicated File (DF) and Elementary File (EF) Structure	3-1
3.1 DF and EFs for ANSI-41 Based Applications	3-1
3.2 File Identifier (ID)	3-2
3.3 Reservation of File IDs	3-2
3.4 Coding of EFs for NAM Parameters and Operational Parameters	3-4
3.4.1 EF _{COUNT} (Call Count).....	3-5
3.4.2 EF _{IMSI_M} (IMSI_M).....	3-6
3.4.3 EF _{IMSI_T} (IMSI_T)	3-9
3.4.4 EF _{TMSI} (TMSI)	3-10
3.4.5 EF _{AH} (Analog Home SID).....	3-11
3.4.6 EF _{AOP} (Analog Operational Parameters)	3-12
3.4.7 EF _{ALOC} (Analog Location and Registration Indicators).....	3-13
3.4.8 EF _{CDMAHOME} (CDMA Home SID, NID)	3-15

CONTENTS

3.4.9 EF _{ZNREGI} (CDMA Zone-Based Registration Indicators)	3-16
3.4.10 EF _{SNREGI} (CDMA System-Network Registration Indicators)	3-18
3.4.11 EF _{DISTREGI} (CDMA Distance-Based Registration Indicators).....	3-20
3.4.12 EF _{ACCOLC} (Access Overload Class ACCOLCp)	3-22
3.4.13 EF _{TERM} (Call Termination Mode Preferences)	3-23
3.4.14 EF _{SSCI} (Suggested Slot Cycle Index)	3-24
3.4.15 EF _{ACP} (Analog Channel Preferences)	3-25
3.4.16 EF _{PRL} (Preferred Roaming List)	3-26
3.4.17 EF _{RUI MID} (Removable UIM_ID)	3-27
3.4.18 EF _{CST} (CDMA Service Table)	3-28
3.4.19 EF _{SPC} (Service Programming Code).....	3-31
3.4.20 EF _{OTAPASPC} (OTAPA/SPC_Enable)	3-33
3.4.21 EF _{NAMLOCK} (NAM_LOCK).....	3-34
3.4.22 EF _{OTA} (OTASP/OTAPA Features)	3-35
3.4.23 EF _{SP} (Service Preferences).....	3-36
3.4.24 EF _{ESNME} (ESN_ME).....	3-37
3.4.25 EF _{Revision} (R-UIM Revision).....	3-38
3.4.26 EF _{PL} (Preferred Languages)	3-39
3.4.27 EF _{SMS} (Short Messages)	3-40
3.4.28 EF _{SMSp} (Short Message Service Parameters).....	3-42
3.4.29 EF _{SMSs} (SMS Status).....	3-45
3.4.30 EF _{SSFC} (Supplementary Services Feature Code Table)	3-46
3.4.31 EF _{SPN} (CDMA Home Service Provider Name)	3-50
3.4.32 EF _{USGIND} (Removable UIM_ID/SF_EUIMID Usage Indicator).....	3-51
3.4.33 EF _{AD} (Administrative Data).....	3-52
3.4.34 EF _{MDN} (Mobile Directory Number)	3-53
3.4.35 EF _{MAXPRL} (Maximum PRL).....	3-55
3.4.36 EF _{SPCS} (SPC Status)	3-56
3.4.37 EF _{ECC} (Emergency Call Codes).....	3-57
3.4.38 EF _{ME3GPDOPC} (ME 3GPD Operation Capability).....	3-59
3.4.39 EF _{3GPDOPM} (3GPD Operation Mode)	3-60

CONTENTS

3.4.40 EF _{SIPCAP} (SimpleIP Capability Parameters)	3-61
3.4.41 EF _{MIPCAP} (MobileIP Capability Parameters)	3-62
3.4.42 EF _{SIPUPP} (SimpleIP User Profile Parameters)	3-63
3.4.43 EF _{MIPUPP} (MobileIP User Profile Parameters).....	3-64
3.4.44 EF _{SIPSP} (SimpleIP Status Parameters).....	3-65
3.4.45 EF _{MIPSP} (MobileIP Status Parameters)	3-66
3.4.46 EF _{SIPPAPSS} (SimpleIP PAP SS Parameters).....	3-67
3.4.47 Reserved	3-68
3.4.48 Reserved	3-69
3.4.49 EF _{PUZL} (Preferred User Zone List)	3-70
3.4.50 EF _{MAXPUZL} (Maximum PUZL)	3-71
3.4.51 EF _{MECRP} (ME-specific Configuration Request Parameters).....	3-72
3.4.52 EF _{HRPDCAP} (HRPD Access Authentication Capability Parameters).....	3-73
3.4.53 EF _{HRPDUPP} (HRPD Access Authentication User Profile Parameters).....	3-74
3.4.54 EF _{CSSPR} (CUR_SSPR_P_REV)	3-75
3.4.55 EF _{ATC} (Access Terminal Class).....	3-76
3.4.56 EF _{EPRL} (Extended Preferred Roaming List)	3-77
3.4.57 EF _{BCSMScfg} (Broadcast Short Message Configuration)	3-78
3.4.58 EF _{BCSMSpref} (Broadcast Short Message Preference)	3-79
3.4.59 EF _{BCSMStable} (Broadcast Short Message Table)	3-81
3.4.60 EF _{BCSMSP} (Broadcast Short Message Parameter)	3-83
3.4.61 EF _{IMPI} (IMS private user identity)	3-84
3.4.62 EF _{DOMAIN} (Home Network Domain Name)	3-85
3.4.63 EF _{IMPU} (IMS public user identity)	3-86
3.4.64 EF _{PCSCF} (Proxy Call Session Control Function)	3-87
3.4.65 EF _{BAKPARA} (Currently used BAK Parameters)	3-89
3.4.66 EF _{UpBAKPARA} (Updated BAK Parameters)	3-91
3.4.67 EF _{MMSN} (MMS Notification)	3-93
3.4.68 EF _{EXT8} (Extension 8)	3-95
3.4.69 EF _{MMSICP} (MMS Issuer Connectivity Parameters)	3-96
3.4.70 EF _{MMSUP} (MMS User Preferences)	3-99

CONTENTS

3.4.71 EF _{MMSUCP} (MMS User Connectivity Parameters).....	3-101
3.4.72 EF _{AuthCapability} (Authentication Capability).....	3-102
3.4.73 EF _{3GCIK} (3G Cipher and Integrity Keys).....	3-103
3.4.74 EF _{DCK} (De-Personalization Control Keys).....	3-104
3.4.75 EF _{GID1} (Group Identifier Level 1).....	3-105
3.4.76 EF _{GID2} (Group Identifier Level 2).....	3-106
3.4.77 EF _{CDMACNL} (CDMA Co-operative Network List).....	3-107
3.4.78 EF _{HOME_TAG} (Home System Tag).....	3-109
3.4.79 EF _{GROUP_TAG} (Group Tag List).....	3-110
3.4.80 EF _{SPECIFIC_TAG} (Specific Tag List).....	3-111
3.4.81 EF _{CALL_PROMPT} (Call Prompt List).....	3-112
3.4.82 EF _{SF_EUIMID} (Short Form EUIMID).....	3-113
3.4.83 EF _{ICCID} (ICC Identification).....	3-114
3.5 Coding of Packet Data Security-Related Parameters.....	3-115
3.5.1 SimpleIP CHAP SS Parameters.....	3-115
3.5.2 MobileIP SS Parameters.....	3-115
3.5.3 HRPD Access Authentication CHAP SS Parameters.....	3-115
3.6 Coding of Shared Secret Used in IETF Protocol.....	3-116
3.7 Multi-Mode Card.....	3-116
4 Authentication and Security.....	4-1
4.1 Parameter Storage and Parameter Exchange Procedures.....	4-1
4.2 Description of Security-Related Functions.....	4-4
4.2.1 Managing Shared Secret Data.....	4-4
4.2.2 Performing Authentication Calculations and Generating Encryption Keys.....	4-6
4.2.3 Managing the Call History Parameter.....	4-8
4.3 Description of OTASP/OTAPA Functions.....	4-9
4.3.1 Elementary Files for OTASP/OTAPA.....	4-9
4.3.1.1 EF _{SPC} (Service Programming Code).....	4-9
4.3.1.2 EF _{OTAPASPC} (OTAPA/SPC_Enable).....	4-9
4.3.1.3 EF _{NAMLOCK} (NAM_LOCK).....	4-9
4.3.1.4 EF _{OTA} (OTASP/OTAPA Features).....	4-9

CONTENTS

4.3.2 Mapping of OTASP/OTAPA Request/Response Messages to R-UIM Commands	4-9
4.3.2.1 Protocol Capability Request/Response Messages.....	4-9
4.3.2.2 MS Key Request/Response Messages	4-10
4.3.2.3 Key Generation Request/Response Messages	4-10
4.3.2.4 SSD Update	4-10
4.3.2.5 Re-Authentication Request/Response Messages	4-10
4.3.2.6 Validation Request/Response Messages.....	4-12
4.3.2.7 Configuration Request/Response Messages	4-12
4.3.2.8 Download Request/Response Messages	4-12
4.3.2.9 SSPR Configuration Request/Response Messages.....	4-12
4.3.2.10 SSPR Download Request/Response Messages.....	4-13
4.3.2.11 OTAPA Request/Response Messages.....	4-13
4.3.2.12 Commit Request/Response Messages	4-13
4.3.2.13 PUZL Configuration Request/Response Messages	4-13
4.3.2.14 PUZL Download Request/Response Messages	4-13
4.3.2.15 3GPD Configuration Request/Response Messages	4-13
4.3.2.16 3GPD Download Request/Response Messages	4-14
4.3.2.17 Secure Mode Request/Response Messages	4-14
4.3.2.18 Service Key Generation Request/Response Messages.....	4-15
4.3.2.19 MMD Configuration Request/Response Messages	4-15
4.3.2.20 MMD Download Request/Response Messages	4-15
4.3.2.21 MMS Configuration Request/Response Messages	4-16
4.3.2.22 MMS Download Request/Response Messages	4-16
4.3.2.23 System Tag Configuration Request/Response Messages	4-16
4.3.2.24 System Tag Download Request/Response Messages	4-16
4.4 Description of Security-Related Commands.....	4-17
4.4.1 Update SSD	4-17
4.4.2 Base Station Challenge.....	4-18
4.4.3 Confirm SSD.....	4-18
4.4.4 Authenticate	4-19
4.4.4.1 Advisory Note on the Use of Run CAVE.....	4-22

CONTENTS

4.4.4.2 Use of Cipher Key Generation Command	4-22
4.4.5 Generate Key/VPM	4-23
4.5 Description of OTASP/OTAPA Commands	4-24
4.5.1 MS Key Request	4-24
4.5.2 Key Generation Request	4-24
4.5.3 Commit	4-26
4.5.4 Validate	4-26
4.5.5 Configuration Request	4-26
4.5.6 Download Request	4-27
4.5.7 SSPR Configuration Request.....	4-27
4.5.8 SSPR Download Request	4-28
4.5.9 OTAPA Request	4-29
4.5.10 PUZL Configuration Request	4-30
4.5.11 PUZL Download Request	4-32
4.5.12 3GPD Configuration Request	4-34
4.5.13 3GPD Download Request	4-34
4.5.14 Secure Mode	4-35
4.5.15 FRESH	4-36
4.5.16 Service Key Generation Request.....	4-37
4.5.17 MMD Configuration Request	4-38
4.5.18 MMD Download Request.....	4-38
4.5.19 MMS Configuration Request	4-39
4.5.20 MMS Download Request	4-39
4.5.21 System Tag Configuration Request	4-40
4.5.22 System Tag Download Request.....	4-40
4.6 ESN and MEID Management Command	4-42
4.6.1 Store ESN_MEID_ME.....	4-42
4.7 Description of Packet Data Security-Related Functions	4-44
4.7.1 Managing Shared Secrets	4-45
4.7.2 Performing Simple IP Authentication	4-45
4.7.3 Performing Mobile IP Authentication	4-45

CONTENTS

4.7.4 HRPD Access Authentication	4-47
4.8 Description of Packet Data Security-Related Commands.....	4-48
4.8.1 Compute IP Authentication.....	4-48
4.8.1.1 CHAP	4-48
4.8.1.2 MN-HA Authenticator	4-49
4.8.1.3 MIP-RRQ Hash.....	4-51
4.8.1.4 MN-AAA Authenticator	4-52
4.8.1.5 HRPD Access Authentication	4-52
4.9 Descriptions of BCMCS Commands.....	4-53
4.9.1 RETRIEVE SK	4-54
4.9.1.1 Command description	4-54
4.9.1.2 Command parameters/data:.....	4-54
4.9.2 Update BAK	4-55
4.9.2.1 Command description	4-55
4.9.2.2 Command parameters/data:.....	4-55
4.9.3 Delete BAK	4-56
4.9.3.1 Command description	4-56
4.9.3.2 Command parameters/data:.....	4-56
4.9.4 RETRIEVE SRTP SK.....	4-57
4.9.4.1 Command description	4-57
4.9.5 Generate Authorization Signature.....	4-58
4.9.5.1 Command description	4-58
4.9.5.2 Command parameters/data:.....	4-59
4.9.6 BCMCS Authentication	4-60
4.9.6.1 Command description	4-60
4.9.6.2 Command parameters/data:.....	4-60
4.10 Descriptions of Application Authentication Commands.....	4-61
4.10.1 Application Authentication Command	4-61
4.11 Description of AKA-related Functions.....	4-63
4.11.1 Authentication and key agreement procedure.....	4-63
4.11.2 Cryptographic Functions.....	4-65

CONTENTS

4.11.3 3G Authentication Command description	4-65
4.11.4 UMAC Generation Command Description	4-65
4.11.5 Restoration of 3G keys	4-66
4.11.6 CONFIRM_KEYS Command description	4-66
4.12 Description of AKA commands	4-66
4.12.1 UMAC Generation	4-66
4.12.2 CONFIRM_KEYS	4-66
5 Additional Air Interface Procedures	5-1
5.1 Registration Procedure.....	5-1
5.1.1 R-UIM Removal and Insertion.....	5-1
5.1.2 Procedure when ESN Changes with TMSI Assigned.....	5-1
5.2 NAM Parameters when no R-UIM is inserted into the ME.....	5-1
5.3 IMSI-Related Parameters in the ME when no IMSI is Programmed in the R-UIM.....	5-2
5.4 Preferred Access Channel Mobile Station ID Type.....	5-3
6 BCMCS Procedures	6-1
6.1 Functionalities of R-UIM and ME	6-1
6.1.1 R-UIM	6-1
6.1.2 ME	6-1
6.2 Key Management	6-1
Annex A (informative): Suggested contents of the EFs at pre-personalization.....	1
Annex B (informative): BCMCS-RELATED Tag Values	1

FIGURES

1	Figure 3-1. Dedicated File Structure.....	3-1
2	Figure 4.2.1-1. Base Station Challenge Function	4-4
3	Figure 4.2.1-2. Update SSD Function, AUTHBS Calculation	4-5
4	Figure 4.2.1-3. Confirm SSD Function	4-6
5	Figure 4.2.2-1. Run CAVE Function	4-7
6	Figure 4.2.2-2. Generate Key/VPM Function	4-8
7	Figure 4.7-1. Authentication Models	4-44
8	Figure 4.7.2-1. Compute IP Authentication Command (CHAP Option)	4-45
9	Figure 4.7.3-1. Computation of MN-AAA Authenticator	4-47
10	Figure 4.7.4-1. HRPD Access Authentication Command.....	4-48
11	Figure 4.11.1-1 AKA Procedures.....	4-64
12	Figure 4.11.4-1 UMAC Generation	4-65

13

TABLES

1 Table 2.1-1 Physical Characteristics2-1
2 Table 2.2-1 Electronic Signals and Transmission Protocols.....2-2
3 Table 2.3-1 Logical Model2-2
4 Table 2.4-1 File Access Conditions2-3
5 Table 2.5-1 Description of the Functions2-4
6 Table 2.6-1 Description of the Commands (Part 1 of 2).....2-5
7 Table 2.7-1 Content of EFs2-8
8 Table 2.7-2 Content of EFs for R-UIM supporting the enhanced phonebook2-9
9 Table 2.8-1 Application Protocol.....2-10
10 Table 0-1 Authentication mechanism.....4-61
11 Table A-1. Summary of R-UIM Files 1

12

FOREWORD

1 This document contains the requirements for the Removable User Identity Module (R-
2 UIM). It is an extension of Subscriber Identity Module (SIM), per latest [17]¹ capabilities, to
3 enable operation in a [14/15] radiotelephone environment. Examples of this environment
4 include, but are not limited to, analog, [14]-based CDMA and the [1-5] family of standards.

5 These requirements are expressed as additions to the current specification of the SIM.
6 The composite R-UIM is comprised of the current SIM specification and this ancillary or
7 “delta” document. The SIM specification is included as a reference. It is intended that all
8 upgrades to the SIM specification will also apply to the R-UIM.

9 The current SIM specifications (see references) address the physical and electrical
10 characteristics of the removable module, along with the user-to-card interface and
11 terminal-to-card signaling protocol. Operation in a [14/15] environment requires that
12 additional commands and responses be developed within the context of this document.
13 This document also defines new Elementary Files (EFs) for storage of parameters that are
14 added for operation in a [14/15] environment.

15 This standard specifies security-related procedures and commands, along with data and
16 information storage items that permit basic operation in the [14/15] environment. Later
17 versions are expected to also address the delivery of [14/15] user features and services via
18 the R-UIM.

19 Although the focus of this document is compatibility with [14/15], the scope of this
20 document may later be expanded to include compatibility with other [15]-related
21 technologies such as TDMA and AMPS.

¹ [] indicates the corresponding document to be cross referenced.

1 No text.

REFERENCES

The following standards are referenced in this text. At the time of publication, the editions indicated were valid. All standards are subject to revision, and parties to agreements based upon this document are encouraged to investigate the possibility of applying the most recent editions of the standards indicated below. ANSI and TIA maintain registers of currently valid national standards published by them.

Normative:

1. 3GPP2 C.S0001-D, *Introduction to cdma2000 Spread Spectrum Systems*, March 2004.
2. 3GPP2 C.S0002-D, *Physical Layer Standard for cdma2000 Spread Spectrum Systems*, March 2004.
3. Reserved.
4. 3GPP2 C.S0004-D, *Signaling Link Access Control (LAC) Standard for cdma2000 Spread Spectrum Systems*, March 2004.
5. 3GPP2 C.S0005-D, *Upper Layer (Layer 3) Signaling Standard for cdma2000 Spread Spectrum Systems*, March 2004.
6. Reserved.
7. 3GPP2 C.S0016-C, *Over-the-Air Service Provisioning of Mobile Stations in Spread Spectrum Systems*, November 2004.
8. C.S0015-B, *Short Message Service for Spread Spectrum Systems*, May 2004.
9. ITU-T Recommendation E.212, "Identification Plan for Land Mobile Stations", 1988.
10. Reserved.
11. Reserved.
12. Reserved
13. Reserved
14. TIA-95-B, *Mobile Station - Base Station Compatibility Standard for Wideband Spread Cellular Systems*, October 2004.
15. 3GPP2 X.S0004-E V2.0, *Cellular Radio Telecommunications Intersystem Operations Mobile Application Part*, July, 2005.
16. TIA/EIA/IS-91-A, *Base Station – Mobile Station Compatibility Specification for 800 MHz Cellular, Auxiliary, and Residential Services*, November 1999.
17. 3GPP TS 51.011 "Third Generation Partnership Project; Technical Specification Group Terminals; Specification of the Subscriber Identity Module-Mobile Equipment (SIM-ME) Interface (Release 4)".
18. ETSI TS 102 221 "Smart cards; UICC-Terminal Interface; Physical and logical Characteristics (Release 6)".
19. Reserved.

REFERENCES

- 1 20. 3GPP2 S.S0053-0 v1.0 *Common Cryptographic Algorithms*, January, 2002.
- 2 21. Reserved.
- 3 22. Reserved.
- 4 23. 3GPP2 X.S0011-C cdma2000 *Wireless IP Network Standard*, August, 2003.
- 5 24. IETF RFC 2002, *IP Mobility Support*, October 1996.
- 6 25. IETF RFC 2794, *Mobile IP Network Access Identifier Extension for IPv4*, March 2000.
- 7 26. IETF RFC 2865, *Remote Authentication Dial In User Service (RADIUS)*, June 2000.
- 8 27. IETF RFC 3012, *Mobile IPv4 Challenge/Response Extensions*, November 2000.
- 9 28. 3GPP2 C.S0024-0, *cdma2000 High Rate Packet Data Air Interface Specification*, October
10 2002.
- 11 29. 3GPP2 A.S0008-0, *Inteoperability Specification (IOS) for High Rate Packet Data (HRPD)*
12 *Network Access Interfaces*, [Addendum 1](#), May 2003.
- 13 30. ETSI TS 131.102, “*Third Generation Partnership Project; Technical Specification Group*
14 *Terminals; Characteristics of the USIM application*”, (Release 6)
- 15 31. ETSI TS 131.103 3rd Generation Partnership Project: Technical Specification Group
16 Terminals; Characteristics of the IP Multimedia Services Identity Module (ISIM)
17 Application (Release 6)
- 18 32. 3GPP2 X.S0013 All-IP Core Network Multimedia Domain -Overview , December, 2003
- 19 33. IETF RFC 3261 “SIP: Session Initialization Protocol’.
- 20 34. IETF RFC 2486 “The Network Access Identifier’.
- 21 35. Reserved
- 22 36. 3GPP2 S.S0083-A, Broadcast-Multicast Service Security Framework, [Jan](#)
23 [2005September 2004](#)
- 24 37. 3GPP2 X.S0016-200 MMS Stage-2, Functional Description, May 2003
- 25 38. ETSI TS 123.038 Alphabets and language-specific information
- 26 39. 3GPP2 X.S0016-310 MMS MM1 Stage-3 Using OMA/WAP, May 2003
- 27 40. 3GPP2 X.S0016-311 MMS MM1 Stage-3 Using M-IMAP for message submission and
28 retrieval
- 29 41. 3GPP2 X.S0016-312 MMS MM1 Stage-3 Using SIP, June 2004
- 30 42. 3GPP2 S.S0055-A V3.0 Enhanced Cryptographic Algorithms September 2005
- 31 43. 3GPP2 C.S0024-A, *cdma2000 High Rate Packet Data Air Interface Specification*, March
32 2004
- 33 44. 3GPP2 C.S0068-0 ME Personalization, [for cdma2000 Spread Spectrum Systems](#), [June](#)
34 [2006](#)
- 35 45. 3GPP2 S.S0086-B IMS Security Framework, December 2005

1 46. IETF RFC 3629 (2003): "UTF-8, a transformation format of ISO 10646".

2 47. *ITU E.118 The international telecommunication charge card, 02/2001*

3

4

5

6 *Informative:*

7 1. ~~TSB58-FC.R1001-D~~, *Administration of Parameter Value Assignments for cdma2000*
8 *Wideband Spread Spectrum Standards*, ~~December~~*April* 2003.

1 GENERAL

1.1 Terms

3GPD. Third Generation Packet Data.

AC. See Authentication Center.

Access Network (AN). The network equipment providing data connectivity between a packet switched data network (typically the Internet) and the access terminals. An access network is equivalent to a base station in [2].

Access Terminal (AT). A device providing data connectivity to a user. An access terminal may be connected to a computing device such as a laptop personal computer or it may be a self-contained data device such as a personal digital assistant. An access terminal is equivalent to a mobile station in [2].

A-key. A secret, 64-bit pattern stored in the mobile station and HLR/AC. It is used to generate or update the mobile station's Shared Secret Data.

Authentication. A procedure used by a base station to validate a mobile station's identity.

Authentication Center (AC). An entity that manages the authentication information related to the mobile station.

BAK. BCMCS related parameter. See [36].

BAK_Expire. BCMCS related parameter. See [36].

BAK_ID. BCMCS related parameter. See [36].

Base Station. A fixed station used for communicating with mobile stations. Depending upon the context, the term base station may refer to a cell, a sector within a cell, an MSC, an OTAF or other part of the wireless system. (See also MSC and OTAF.)

BCMCS. Broadcast Multicast Service.

BCMCS_Flow_ID. BCMCS related parameter. See [36].

BCMCS Root Key. A secret 128-bit pattern used for BCMCS (Broadcast Multicast Service). Defined as 'Registration Key' in [36].

CAVE. The algorithm currently used in [15] for Authentication and Key Generation.

CRC. See Cyclic Redundancy Code.

Cyclic Redundancy Code (CRC). A class of linear error detecting codes which generate parity check bits by finding the remainder of a polynomial division.

DF. Dedicated File.

Diffie/Hellman. The key exchange mechanism used by [7].

ECMEA. Enhanced Cellular Message Encryption Algorithm

- 1 **ECMEA_NF.** Enhanced Cellular Message Encryption Algorithm (Non Financial)
- 2
- 3 **EF.** Elementary File.
- 4 **Electronic Serial Number (ESN).** A 32-bit number assigned by the mobile station
- 5 manufacturer, uniquely identifying the mobile station equipment.
- 6 **ESN.** See Electronic Serial Number.
- 7 **EUIMID.** Expanded R-UIM Identifier.
- 8 **HLR.** See Home Location Register.
- 9 **Home Location Register (HLR).** The location register to which a MIN/IMSI is assigned for
- 10 record purposes such as subscriber information.
- 11 **Home System.** The cellular system in which the mobile station subscribes for service.
- 12 **ICC.** Integrated Circuit(s) Card.
- 13 **ICCID.** ICC Identification.
- 14 **IMS.** IP Multimedia Subsystem.
- 15 **IMSI.** See International Mobile Subscriber Identity.
- 16 **IMSI_M.** MIN-based IMSI using the lower 10-digits to store the MIN.
- 17 **IMSI_T.** True IMSI not associated with MIN. This could be 15 digits or fewer.
- 18 **IMS Root Key.** A secret 128-bit pattern used for IMS (IP Multimedia Subsystem).
- 19 **International Mobile Subscriber Identity (IMSI).** A method of identifying subscribers in
- 20 the land mobile service as specified in [9].
- 21 **IRM.** International Roaming MIN
- 22 **Long Code Mask.** A 42-bit binary number that creates the unique identity of the long
- 23 code. See also Public Long Code, Private Long Code, Public Long Code Mask, and Private
- 24 Long Code Mask.
- 25 **LF_EUIMID.** Long form of EUIMID, which is ICCID based. *In this document this term refers*
- 26 *to the entire 20 digit/ 10 octet contents of EF_{ICCID} even though this will include a check digit and*
- 27 *a padding digit.*
- 28 **LSB.** Least significant bit.
- 29 **M/O.** Mandatory/Optional.
- 30 **MAC.** Message authentication code
- 31 **MAC-A.** MAC used for authentication and key agreement
- 32 **MAC-I.** Message Authentication Code for message integrity. The 32-bit output of the
- 33 message integrity algorithm that allows the receiver to authenticate the message
- 34 **MCC.** See Mobile Country Code

- 1 **ME.** Mobile Equipment.
- 2 **MEID.** Mobile Equipment Identifier.
- 3 **MF.** Master File.
- 4 **Mobile Country Code (MCC).** A part of the E.212 IMSI identifying the home country. See
5 [9].
- 6 **Mobile Directory Number (MDN).** A dialable directory number which is not necessarily
7 the same as the mobile station's air interface identification, i.e., MIN, IMSI_M or IMSI_T.
- 8 **Mobile Equipment (ME).** An R-UIM capable mobile station without an R-UIM inserted.
- 9 **MIN.** See Mobile Identification Number.
- 10 **MNC.** See Mobile Network Code.
- 11 **Mobile Identification Number (MIN).** The 34-bit number that is a digital representation
12 of the 10-digit number assigned to a mobile station.
- 13 **Mobile Network Code (MNC).** A part of the E.212 IMSI identifying the home network
14 within the home country. See [9].
- 15 **Mobile Station.** A station, fixed or mobile, which serves as the end user's wireless
16 communication link with the base station. Mobile stations include portable units (e.g.,
17 hand-held personal units) and units installed in vehicles.
- 18 **Mobile Station Originated Call.** A call originating from a mobile station.
- 19 **Mobile Station Terminated Call.** A call received by a mobile station (not to be confused
20 with a disconnect or call release).
- 21 **MSB.** Most significant bit.
- 22 **NAM.** See Number Assignment Module.
- 23 **Network.** A network is a subset of a wireless system, such as an area-wide wireless
24 network, a private group of base stations, or a group of base stations set up to handle a
25 special requirement. A network can be as small or as large as needed, as long as it is fully
26 contained within a system. See also System.
- 27 **Network Identification (NID).** A number that uniquely identifies a network within a
28 wireless system. See also System Identification.
- 29 **NID.** See Network Identification.
- 30 **Number Assignment Module (NAM).** A set of MIN/IMSI-related parameters stored in the
31 mobile station.
- 32 **OTAF.** See Over-the-Air Service Provisioning Function.
- 33 **Over-the-Air Service Provisioning Function (OTAF).** A configuration of network
34 equipment that controls OTASP functionality and messaging protocol.
- 35 **OTAPA.** See Over-the-Air Parameter Administration.

- 1 **OTASP.** See Over-the-Air Service Provisioning.
- 2 **Over-the-Air Parameter Administration (OTAPA).** Network initiated OTASP process of
3 provisioning mobile station operational parameters over the air interface.
- 4 **Over-the-Air Service Provisioning (OTASP).** A process of provisioning mobile station
5 operational parameters over the air interface.
- 6 **Parity Check Bits.** Bits added to a sequence of information bits to provide error
7 detection, correction or both.
- 8 **P-CSCF.** Proxy Call Session Control Function
- 9 **Preferred Roaming List (PRL).** See SSPR.
- 10 **Private Long Code.** The long code characterized by the private long code mask.
- 11 **Private Long Code Mask.** The long code mask used to form the private long code.
- 12 **Pseudo-Electronic Serial Number (P-ESN).** A 32-bit number hashed from MEID.
- 13 **Pseudo-UIMID (P-UIMID).** A 32-bit number derived from EUIM_ID using a specific
14 algorithm.
- 15 **Release.** A process that the mobile station and base station use to inform each other of
16 call disconnect.
- 17 **RFU.** Reserved for future use.
- 18 **Roamer.** A mobile station operating in a wireless system (or network) other than the one
19 from which service was subscribed.
- 20 **Root Key.** A secret 128-bit pattern permanently stored in the R-UIM.
- 21 **R-UIM.** Removable UIM.
- 22 **SF_EUIMID.** Short form of EUIMID. An EUIMID selected from MEID numbering resources.
- 23 **Secure Mode.** Network initiated mode of communicating operational parameters between
24 a mobile station and network based provisioning entity in an encrypted form.
- 25 **Service Option.** A service capability of the system. Service options may be applications
26 such as voice, data or facsimile. See informative [1].
- 27 **Shared Secret Data (SSD).** A 128-bit pattern stored in the mobile station (in semi-
28 permanent memory) and known by the base station. SSD is a concatenation of two 64-bit
29 subsets: SSD_A, which is used to support the authentication procedures, and SSD_B,
30 which serves as one of the inputs to the process generating the encryption mask and
31 private long code.
- 32 **SID.** See System Identification.
- 33 **SIP.** Session Initialization Protocol
- 34 **SIM.** Subscriber Identity Module.
- 35 **SK.** BCMCS related parameter. See [36].

- 1 **SK RAND.** BCMCS related parameter. See [36].
- 2 **SMCK.** Secure Mode Ciphering Key.
- 3 **SPASM.** See Subscriber Parameter Administration Security Mechanism.
- 4 **SPC.** Service Programming Code.
- 5 **SRTP.** Secure Real Time Transport Protocol. See [36].
- 6 **SSD.** See Shared Secret Data.
- 7 **SSPR.** See System Selection for Preferred Roaming.
- 8 **Subscriber Parameter Administration Security Mechanism (SPASM).** Security
9 mechanism protecting parameters and indicators of active NAM from programming by an
10 unauthorized network entity during the OTAPA session.
- 11 **SW1/SW2.** Status Word 1/Status Word 2.
- 12 **System.** A system is a wireless telephone service that covers a geographic area such as a
13 city, metropolitan region, county or group of counties. See also Network.
- 14 **System Identification (SID).** A number uniquely identifying a wireless system.
- 15 **System Selection Code.** A part of the Activation Code that specifies the user selection of
16 a Band and a Block operated by the selected service provider.
- 17 **System Selection for Preferred Roaming (SSPR).** A feature that enhances the mobile
18 station system acquisition process based on the set of additional parameters stored in the
19 mobile station in the form of a Preferred Roaming List (PR_LIST_{s-p}).
- 20 **TK.** BCMCS related parameter. See [36].
- 21 **TK RAND.** BCMCS related parameter. See [36].
- 22 **TMSI.** Temporary Mobile Station Identity.
- 23 **UAK.** UIM Authentication Key. A 128-bit pattern produced by AKA that is used for R-UIM
24 authentication.
- 25 **UMAC.** UIM-Present MAC. A 32-bit output of the UMAC algorithm computed by R-
26 UIM based on MAC-I, which provides a means for the mobile station to prove that the R-
27 UIM was present at the time the message is formed.
- 28 **UCS2.** Universal Multiple-Octet Coded Character Set.
- 29 **UIM.** User Identity Module.
- 30 **UIM_ID.** An (up to) 56-bit electronic identification (ID) number that is unique to the R-UIM.
- 31 **URI.** Universal Resource Identifier.
- 32 **VPM.** Voice Privacy Mask.
- 33 **WLAN Root Key.** A secret 128-bit pattern used for WLAN services.
- 34

- 1 No text.

1 **2 PHYSICAL, ELECTRICAL, AND LOGICAL INTERFACES**

2 **2.1 Physical Interface**

3 The physical characteristics of the R-UIM shall follow the definitions specified in the
4 sections of [17] shown in Table 2.1-1 .

5
6 **Table 2.1-1 Physical Characteristics**

Section of [17]	Title
4	Physical Characteristics
4.1	ID-1 UICC
4.2	Plug-In UICC, including Annex A (Normative)
4.3	Temperature range for card operations
4.4	Contacts
4.4.2	Contact activation and deactivation
4.4.3	Inactive contacts
4.4.4	Contact pressure

7

2.2 Electrical Interface

The electrical characteristics of the R-UIM shall follow the definitions specified in the sections of [17] shown in Table 2.2-1.

Table 2.2-1 Electronic Signals and Transmission Protocols

Section of [17]	Title
5	Electronic Signals and Transmission Protocols
5.1	Electrical specifications
5.2	Initial communication establishment procedures
5.2.1	Error handling for speed enhancement
5.3	Transmission protocols
5.4	Clock

Terminals and R-UIM supporting other voltage technologies than Class A (see section 5.1 of 18) shall support at least 2 consecutive voltage classes, i.e. classes A and B, or classes B and C.

2.3 Logical Interface

The logical interface of the R-UIM shall follow the definitions specified in the sections of [17] shown in Table 2.3-1. The Dedicated file ID for CDMA (used for EFs in section 3.4) is '7F25'.

Table 2.3-1 Logical Model

Section of [17]	Title
6	Application and File structure
6.1	SIM application structure
6.4	File types
6.4.1	Dedicated files
6.4.2	Elementary files
6.4.2.1	Cyclic EF
6.5	Methods for selecting a file

2.4 Security Features

Security-Related procedures and protocols are defined in section 4.

1 2.4.1 2G Authentication and Key Generation Procedure

2 See section 4.1 and 4.2.

3 2.4.2 Algorithms and Processes

4 The algorithm used by the R-UIM for authentication and key generation is CAVE (see section
5 4.1 and 4.2).

6 2.4.3 File Access Conditions

7 The file access conditions of the R-UIM shall follow the definitions specified in the section
8 of [17] shown in Table 2.4-1.

9

10

Table 2.4-1 File Access Conditions

Section of [17]	Title
7.3	File Access Conditions

11

12 2.4.4 3G AKA (Authentication and Key Agreement) Procedure and Function

13 See section 4.11 and 4.12.

14

2.5 Function Description

The functions of the R-UIM shall follow the definitions specified in the sections of [17] shown in Table 2.5-1. For [15], the following functions from section 4 are used: Update SSD, Base Station Challenge, Confirm SSD, Run CAVE, Generate Key/VPM and Store ESN_MEID_ME. These functions are applicable for CDMA operation; other modes are outside of the scope of this document. They shall not be executable unless DF_{CDMA} or any sub-directory under DF_{CDMA} has been selected as the current directory and a successful CHV1 verification procedure has been performed.

Table 2.5-1 Description of the Functions

Section of [17]	Title
8	Description of The Functions
8.1	SELECT
8.2	STATUS
8.3	READ BINARY
8.4	UPDATE BINARY
8.5	READ RECORD
8.6	UPDATE RECORD
8.7	SEEK
8.8	INCREASE
8.9	VERIFY CHV
8.10	CHANGE CHV
8.11	DISABLE CHV
8.12	ENABLE CHV
8.13	UNBLOCK CHV
8.14	INVALIDATE
8.15	REHABILITATE
8.17	SLEEP
8.18	TERMINAL PROFILE
8.19	ENVELOPE
8.20	FETCH
8.21	TERMINAL RESPONSE

1 **2.6 Command Description**

2 The commands used with the R-UIM shall follow the definitions specified in the sections
 3 of [17] shown in Table 2.6-1. The commands used to run CAVE are specified in section 4.4.

4
 5 **Table 2.6-1 Description of the Commands (Part 1 of 2)**

Section of [17]	Title
9	Description of the Commands
9.1	Mapping Principles
9.2	Coding of the Commands
9.2.1	SELECT*
9.2.2	STATUS
9.2.3	READ BINARY
9.2.4	UPDATE BINARY
9.2.5	READ RECORD
9.2.6	UPDATE RECORD
9.2.7	SEEK
9.2.8	INCREASE
9.2.9	VERIFY CHV
9.2.10	CHANGE CHV
9.2.11	DISABLE CHV
9.2.12	ENABLE CHV
9.2.13	UNBLOCK CHV
9.2.14	INVALIDATE
9.2.15	REHABILITATE

6

1

Table 2.6-1 Description of the Commands (Part 2 of 2)

Section of [17]	Title
9.2.17	SLEEP
9.2.18	GET RESPONSE
9.2.19	TERMINAL PROFILE
9.2.20	ENVELOPE
9.2.21	FETCH
9.2.22	TERMINAL RESPONSE
9.3	Definition and coding
9.4	Status conditions returned by the card
9.4.1	Responses to commands which are correctly executed
9.4.2	Responses to commands which are postponed
9.4.3	Memory management
9.4.4	Referencing management
9.4.5	Security management
9.4.6	Application independent errors
9.4.7	Commands versus possible status responses

2 The INCREASE command is coded as specified in TS 102 221 [18] with the following
3 limitations:

- 4 - Class = 'A0'
- 5 - P1, P2 = '00'
- 6 - P3 = 'Record length of selected cyclic file'

7 The response is according to the command parameters, as defined in TS 102 221 [18]

8

9 *Response parameters/data in case of DF_{CDMA}:

10

Byte(s)	Description	Length
1 - 2	RFU	2
3 - 4	Total amount of memory of the selected directory which is not allocated to any of the DFs or EFs under the selected directory	2
5 - 6	File ID	2
7	Type of file (see subclause 9.3)	1
8 - 12	RFU	5
13	Length of the following data (byte 14 to the end)	1
14 - 34	CDMA specific data	21

11

1 CDMA specific data:

Byte(s)	Description	Length
14	File characteristics (see detail 1)	1
15	Number of DFs which are a direct child of the current directory	1
16	Number of EFs which are a direct child of the current directory	1
17	Number of CHVs, UNBLOCK CHVs and administrative codes	1
18	RFU	1
19	CHV1 status (see detail 2)	1
20	UNBLOCK CHV1 status (see detail 2)	1
21	CHV2 status (see detail 2)	1
22	UNBLOCK CHV2 status (see detail 2)	1
23	RFU	1
24 - 34	Reserved for the administrative management	$0 \leq \text{lgth} \leq 11$

2

3 Bytes 1 - 22 are mandatory and shall be returned by the R-UIM. Bytes 23 and following are
4 optional and may not be returned by the R-UIM.

5 NOTE 1: Byte 35 and following are RFU.

6 For the above bytes R-UIM shall follow definitions in section 9.2.1 of [17].

7 2.6.1 R-UIM Supply Voltage Identification

8 R-UIM supporting Class B or C operating conditions (as specified in [17]) shall support the
9 supply voltage indication as specified in section 9.2.1 of [17]. The table below shows the
10 CDMA equivalent command for the listed GSM command.

11

GSM command	CDMA Equivalent command
SELECT GSM	SELECT CDMA

12

2.7 Content of EFs

The content of the EFs of the R-UIM shall include the sections of [17] shown in Table 2.7-1.

Table 2.7-1 Content of EFs

Section of [17]	Title
10.1	Contents of the EFs at the MF level
10.1.1	EF _{ICCID} (ICC Identification) (3)
10.2	DFs at the GSM application level
10.5	Contents of files at the telecom level
10.5.1	EF _{ADN} (Abbreviated dialing numbers)(1)
10.5.2	EF _{FDN} (Fixed dialing numbers)(1) / (2)
10.5.8	EF _{LND} (Last number dialed)(1)
10.5.9	EF _{SDN} (Service Dialing Numbers)(1)
10.5.10	EF _{EXT1} (Extension1)(1)
10.5.11	EF _{EXT2} (Extension2)(1)
10.5.12	EF _{EXT3} (Extension3)(1)
10.6	DFs at the telecom level
10.6.1	Contents of files at the telecom graphics level
10.6.1.1	EF _{IMG} (Image)
10.6.1.2	Image Instance Data Files

Notes:

- (1) The numbers are stored in the same format as [17].
- (2) See FDN procedures in [17] Annex B. The table below shows the CDMA equivalent of GSM files that are specially handled in FDN mode:

GSM File	CDMA Equivalent File
DF _{GSM}	DF _{CDMA}
EF _{LOCI}	EF _{TMSI}
EF _{IMSI}	EF _{IMSI_M} , EF _{IMSI_T}

(3) See section 3.4.83 for some additional restrictions on the contents of EF_{ICCID}.

In addition, the R-UIM may optionally provide an enhanced phonebook in a DF_{PHONEBOOK} (File ID '5F3A') under DF_{TELECOM} as defined in [30]. In this case, the content of DF_{PHONEBOOK}

on the R-UIM may include the sections of [30] shown in Table 2.7-2, with the following restrictions:

- PIN shall be interpreted as CHV1 and PIN2 shall be interpreted as CHV2.
- SFIs (Short File Identifiers) shall not apply to the R-UIM.

EF_{ADN} and EF_{PBR} shall always be present if the $DF_{PHONEBOOK}$ is present.

To ensure proper inter-working in all terminals, the first EFs ADN and EXT1 files, if under $DF_{PHONEBOOK}$, are linked to the corresponding files under $DF_{TELECOM}$, i.e. $EF_{ADN} = '6F3A'$ and $EF_{EXT1} = '6F4A'$, respectively. This means that the contents of EFs ADN and EXT1 files under $DF_{PHONEBOOK}$ shall remain synchronized with those under $DF_{TELECOM}$.

In addition, the Phonebook Restrictions defined in chapter 4.4.2.14 of [30] apply to the R-UIM.

Table 2.7-2 Content of EFs for R-UIM supporting the enhanced phonebook

Section of [30]	Title
4.4.2.1	EF_{PBR} (Phone Book Reference file) (1)
4.4.2.2	EF_{IAP} (Index Administration Phone book)
4.4.2.3	EF_{ADN} (Abbreviated dialing numbers) (1)
4.4.2.4	EF_{EXT1} (Extension1)
4.4.2.6	EF_{GRP} (Grouping file)
4.4.2.7	EF_{AAS} (Additional number Alpha String)
4.4.2.8	EF_{GAS} (Grouping Information Alpha String)
4.4.2.9	EF_{ANR} (Additional Number) (2)
4.4.2.10	EF_{SNE} (Second Name Entry) (2)
4.4.2.13	EF_{EMAIL} (e-mail address) (2)

Notes:

- The files EF_{PBC} (Phone Book Control), EF_{UID} (Unique Identifier), and EF_{CCP1} (Capability Configuration Parameters 1) are not applicable to the R-UIM.
- “ADN File SFI” should be interpreted as “Last byte of ADN File Identifier” whenever a one-byte field is used to refer to an ADN file.

2.8 Application Protocol

The application protocol of the R-UIM shall follow the definitions specified in the sections of [17] shown in Table 2.8-1.

Table 2.8-1 Application Protocol

Section of [17]	Title
11	Application protocol
11.1	General procedures
11.2.5	Administrative information request
11.2.6 (1)	SIM service table request
11.2.7 (2)	SIM phase request
11.2.8	SIM Presence Detection and Proactive Polling

(1) To CDMA mode, ME should read EF CDMA service table.

(2) To CDMA mode, ME should read EF R-UIM revision.

1 **2.9 CDMA Card Application Toolkit**

2 Reserved.

3

4 **2.10 Coding of Alpha Fields in the R-UIM for UCS2**

5 Reserved.

3 MULTI-MODE R-UIM DEDICATED FILE (DF) AND ELEMENTARY FILE (EF) STRUCTURE

Figure 3-1 depicts the multi-mode R-UIM file structure.

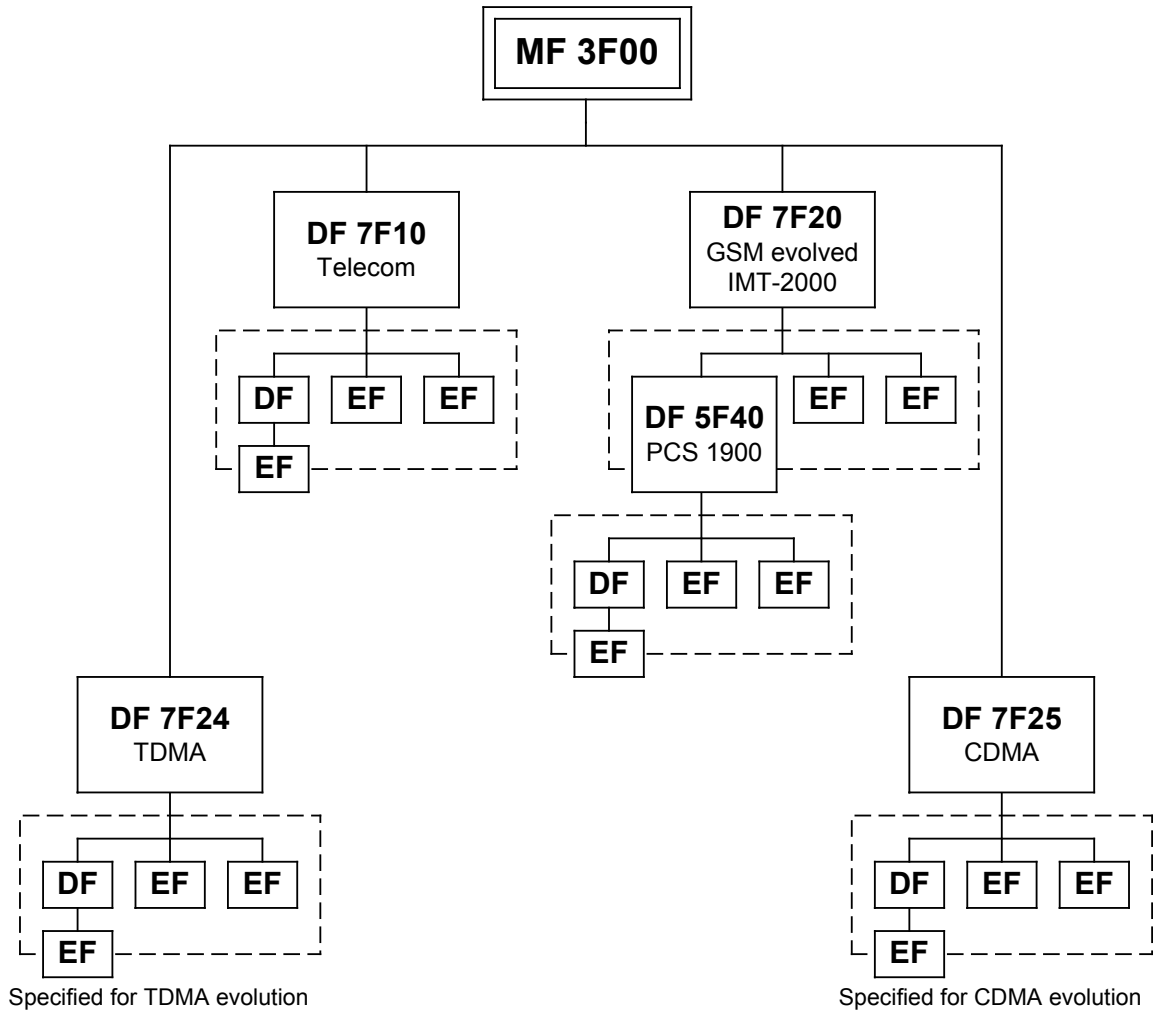

Figure 3-1. Dedicated File Structure

3.1 DF and EFs for ANSI-41 Based Applications

EFs assigned under DF '7F25' for storage of Number Assignment Module (NAM) parameters and operational parameters that are required for Analog/CDMA operation are based on [14] and the family of standards defined in [1].

Section 3.4 shows the detailed coding of these EFs. In this document, only single-NAM operation for CDMA is supported and therefore, each parameter is included once.

3.2 File Identifier (ID)

A file ID is used to address or identify each specific file. The file ID consists of two bytes and shall be coded in hexadecimal notation. File IDs are specified in section 3.4.

The first byte identifies the type of file. The numbering scheme for DFs and EFs is inherited from [17] as:

- '3F': Master File;
- '7F': 1st level Dedicated File;
- '5F': 2nd level Dedicated File;
- '2F': Elementary File under the Master File;
- '6F': Elementary File under the 1st level Dedicated File;
- '4F': Elementary File under the 2nd level Dedicated File.

File IDs shall be subject to the following conditions:

- the file ID shall be assigned at the time of creation of the file concerned;
- no two files under the same parent shall have the same ID;
- a child and any parent, either immediate or remote in the hierarchy, e.g. grandparent, shall never have the same file ID.

In this way each file is uniquely identified.

3.3 Reservation of File IDs

In addition to the identifiers used for the files specified in the present document, the following file IDs are reserved for use by GSM and CDMA.

Dedicated Files:

- administrative use:
'7F 4X', '5F 1X', '5F 2X'
- operational use:
'7F 10' (DF_{TELECOM}), '7F 20' (DF_{GSM}), '7F 21' (DF_{DCS1800}), '7F 22' (DF_{IS-41}), '7F 23' (DF_{FP-CTS}), '7F 24' (DF_{TIA/EIA-136}), '7F 25' (DF_{TIA/EIA-95}), and '7F 2X', where X ranges from '6' to 'F'.
- reserved under '7F10':
'5F 50' (DF_{GRAPHICS})
- reserved under '7F20':
'5F 30' (DF_{IRIDIUM}), '5F 31' (DF_{Globalstar}), '5F 32' (DF_{ICO}), '5F 33' (DF_{ACeS}), '5F 3X', where X ranges from '4' to 'F' for other MSS.
'5F 40' (DF_{PCS-1900}), '5F 4Y' where Y ranges from '1' to 'F';
'5F 5X' where X ranges from '0' to 'F';
'5F 60' (DF_{CTS}), '5F 6Y' where Y ranges from '1' to 'F';
'5F 70' (DF_{SoLSA}), '5F 7Y' where Y ranges from '1' to 'F';
'5F YX' where Y ranges from '8' to 'F' and X from '0' to 'F'.

Elementary files:

- administrative use:
'6F XX' in the DFs '7F 4X'; '4F XX' in the DFs '5F 1X', '5F 2X'
'6F 1X' in the DFs '7F 10', '7F 20', '7F 21', '7F 25';
'4F 1X' in all 2nd level DFs
'2F 01', '2F EX' in the MF '3F 00';
- operational use:
'6F 2X', '6F 3X', '6F 4X' in '7F 10' and '7F 2X';
'4F YX', where Y ranges from '2' to 'F' in all 2nd level DFs.

1 ‘2F 1X’ in the MF ‘3F 00’.

2 In all the above, X ranges, unless otherwise stated, from ‘0’ to ‘F’, inclusive.

3

1 **3.4 Coding of EFs for NAM Parameters and Operational Parameters**

2 All quantities shown in the EF descriptions are represented in binary format, unless
3 otherwise specified. All unused, allocated bytes of memory are set to '00' unless otherwise
4 specified. Some bits are marked as RFU. Some or all of these RFU bits may be used in the
5 future for additional parameters. Therefore, all RFU bits shall be set to '0' (zero). The ME
6 shall ignore the state of all RFU bits.

7 The dedicated file ID used for EFs in this section is '7F25' (CDMA).

8 [14] and [1] store parameters in several different types of memory. Variables stored in
9 permanent memory use the subscript p. Variables stored in semi-permanent memory use
10 the subscript s-p. When an R-UIM is used, some of these variables are maintained in the
11 R-UIM while other variables are maintained in the ME.

12

1 3.4.1 EF_{COUNT} (Call Count)

2 This EF stores the value of Call Count, COUNT_{s-p}.

3

Identifier: '6F21'		Structure: cyclic		Mandatory
Record Length: 2 bytes		Update activity: high		
Access Conditions:				
READ		CHV1		
UPDATE		CHV1		
INCREASE		CHV1		
INVALIDATE		ADM		
REHABILITATE		ADM		
Bytes	Description	M/O	Length	
1 - 2	COUNT _{s-p}	M	2 bytes	

4 COUNT_{s-p} is contained in the least significant 6 bits of the two-byte field.

5

6 Coding:

7

Byte 1:

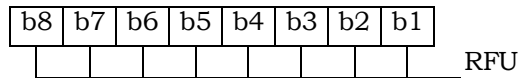

8

9

Byte 2:

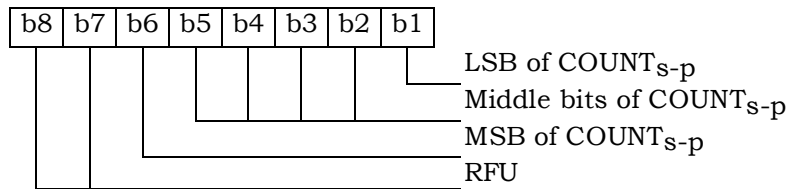

10

3.4.2 EF_{IMSI_M} (IMSI_M)

This EF stores the five components of IMSI_M.

Identifier: '6F22'		Structure: transparent		Mandatory	
File size: 10 bytes			Update activity: low		
Access Conditions:					
READ		CHV1			
UPDATE		ADM			
INVALIDATE		ADM			
REHABILITATE		CHV1			
Bytes	Description	M/O	Length		
1	IMSI_M_CLASS _p	M	1 byte		
2 - 3	IMSI_M_S2 from IMSI_M_S _p	M	2 bytes		
4 - 6	IMSI_M_S1 from IMSI_M_S _p	M	3 bytes		
7	IMSI_M_11_12 _p	M	1 byte		
8	IMSI_M_PROGRAMMED/ IMSI_M_ADDR_NUM _p	M	1 byte		
9 -10	MCC_M _p	M	2 bytes		

- IMSI_M_CLASS_p - Class assignment of the IMSI_M.
- IMSI_M_ADDR_NUM_p - Number of IMSI_M address digits.
- MCC_M_p - Mobile country code.
- IMSI_M_11_12_p - 11th and 12th digits of the IMSI_M.
- IMSI_M_S_p - The least significant 10 digits of the IMSI_M.

Coding:

Byte 1:

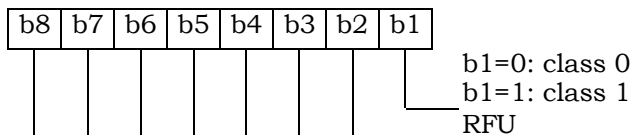

Byte 2, byte 3, byte 4, byte 5 and byte 6 are encoded as described in [14], Section 6.3.1.1, "Encoding of IMSI_M_S and IMSI_T_S".

Byte 2:

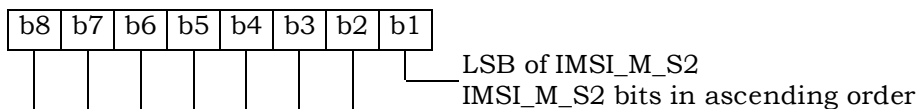

Byte 3:

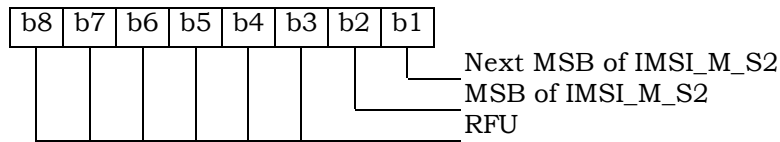

1
2

Byte 4:

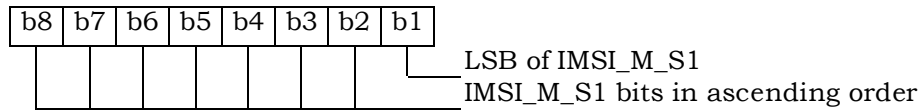

3
4

Byte 5:



5
6

Byte 6:

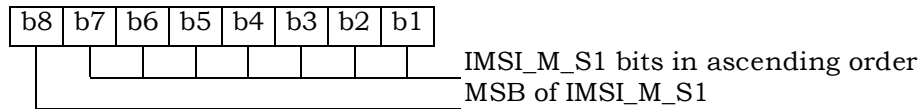

7
8

Byte 7 is encoded as described in [14], Section 6.3.1.2, "Encoding of IMSI_M_11_12 and IMSI_T_11_12".

9
10

Byte 7:

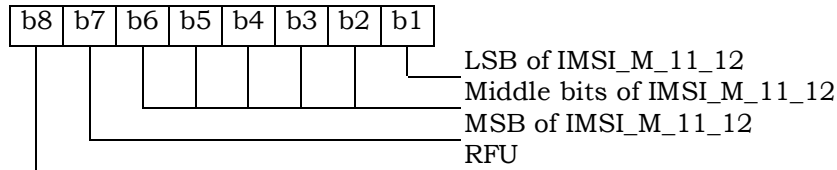

12
13

Byte 8 is the binary equivalent of the IMSI_M_ADD_NUM, as described in [14], Section 6.3.1, "Mobile Station Identification Number".

14
15

Byte 8:

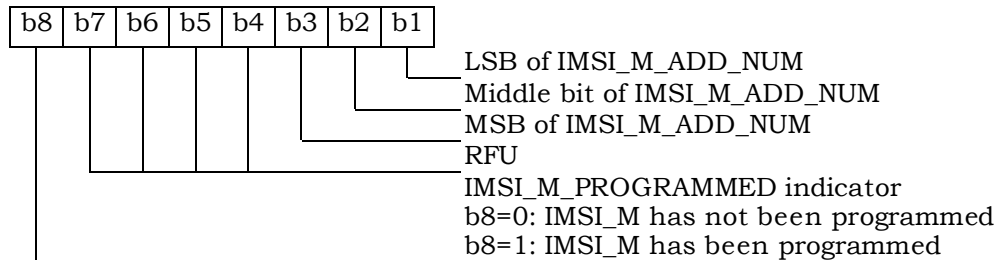

16
17

IMSI_M_PROGRAMMED shall be set to '1' if an IMSI_M has been programmed (IMSI_M would contain a MIN for systems that comply with [14]); if an IMSI_M has not been programmed, it shall be set to '0'.

1 Byte 9 and byte 10 are encoded as described in [14] Section 6.3.1.3, "Encoding of the
 2 MCC_M and MCC_T".

3
 4 Byte 9:

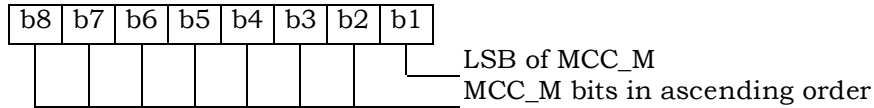

5
 6 Byte 10:

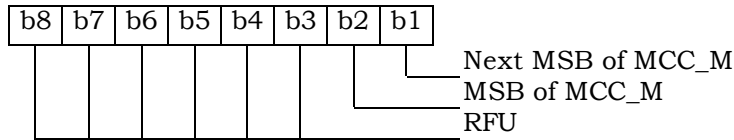

7
 8 For R-UIM applications in systems that comply with [14], the parameter "MIN" is stored in
 9 EF IMSI_M. For these instances, the 10 bits of "MIN2" are stored in bytes 2 and 3, with the
 10 coding shown above, while the 24 bits of "MIN1" are stored in bytes 4, 5, and 6.

11 The selection of IMSI_M or IMSI_T for use in the authentication process shall be in
 12 accordance with [14] Section 6.3.12.1 and [5] Section 2.3.12.1, which stipulate that the
 13 "MIN" portion of IMSI_M shall be used as an input parameter of the authentication
 14 calculation if IMSI_M is programmed and that a 32-bit subset of IMSI_T shall be used if
 15 only IMSI_T has been programmed.

16

1 3.4.3 EF_{IMSI_T} (IMSI_T)

2 This EF stores the five components of IMSI_T.

3

Identifier: '6F23'		Structure: transparent		Mandatory
File size: 10 bytes		Update activity: low		
Access Conditions:				
READ		CHV1		
UPDATE		ADM		
INVALIDATE		ADM		
REHABILITATE		CHV1		
Bytes	Description	M/O	Length	
1	IMSI_T_CLASS _p	M	1 byte	
2 – 3	IMSI_T_S2 from IMSI_T_S _p	M	2 bytes	
4 – 6	IMSI_T_S1 from IMSI_T_S _p	M	3 bytes	
7	IMSI_T_11_12 _p	M	1 byte	
8	IMSI_T_PROGRAMMED/ IMSI_T_ADDR_NUM _p	M	1 byte	
9 –10	MCC_T _p	M	2 bytes	

4

5 All byte descriptions, encodings and reference sections in [14] are identical to those
6 described in Section 3.4.2, except that all references to “IMSI_M” shall apply to “IMSI_T”.

7 EF IMSI_T is not used to store a MIN.

8

3.4.4 EF_{TMSI} (TMSI)

This EF stores the Temporary Mobile Station Identity (TMSI). TMSI is assigned by the serving network and consists of 4 components, ASSIGNING_TMSI_ZONE_LEN_{s-p}, ASSIGNING_TMSI_ZONE_{s-p}, TMSI_CODE_{s-p}, and TMSI_EXP_TIME_{s-p}.

Identifier: '6F24'		Structure: transparent		Mandatory
File size: 16 bytes			Update activity: high	
Access Conditions:				
READ		CHV1		
UPDATE		CHV1		
INVALIDATE		ADM		
REHABILITATE		CHV1		
Bytes	Description	M/O	Length	
1	ASSIGNING_TMSI_ZONE_LEN _{s-p}	M	1 byte	
2 - 9	ASSIGNING_TMSI_ZONE _{s-p}	M	8 bytes	
10 - 13	TMSI_CODE _{s-p}	M	4 bytes	
14 - 16	TMSI_EXP_TIME _{s-p}	M	3 bytes	

Coding:
Byte 1:

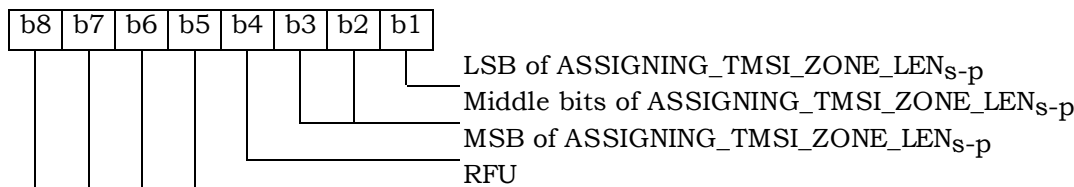

Bytes 2 through 9 store the (up to) 8-octet TMSI Zone as described in Sections 6.3.15, 6.3.15.1 and 6.3.15.2 of [14]. These sections are entitled “Temporary Mobile Station Identity”, “Overview” and “TMSI Assignment Memory” respectively. In each case the lowest-order octet shall be stored in the lowest-order byte (i.e., byte 2) of each set of contiguous 8 bytes, and successively higher octets stored in the next highest order bytes. Unused bytes shall be set to ‘00’.

Bytes 10 through 13 store the (2 to 4 octet) TMSI Code as described in the sections of [14] referenced above. In each case the lowest-order octet shall be stored in the lowest-order byte (i.e., byte 10) of each set of contiguous 4 bytes, and successively higher octets stored in the next highest order bytes. Unused bytes shall be set to ‘00’.

Bytes 14 through 16 store the TMSI Expiration Time as described in the sections of [14] referenced above. In each case the lowest-order octet shall be stored in the lowest-order byte (i.e., byte 14) of each set of contiguous 3 bytes, and successively higher octets stored in the next highest order bytes.

1 3.4.5 EF_{AH} (Analog Home SID)

2 This EF identifies the home SID when the mobile station is operating in the analog mode.

3

Identifier: '6F25'		Structure: transparent		Mandatory
File size: 2 bytes		Update activity: low		
Access Conditions:				
READ		CHV1		
UPDATE		CHV1		
INVALIDATE		ADM		
REHABILITATE		ADM		
Bytes	Description	M/O	Length	
1-2	Analog home SID (HOME_SID _p)	M	2 bytes	

4

5 Coding:

6

Byte 1:

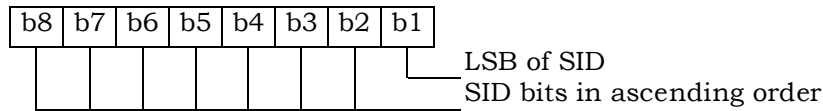

7

8

Byte 2:

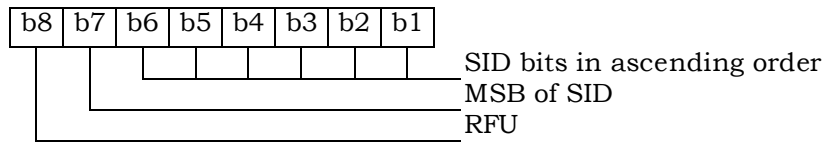

9

3.4.6 EF_{AOP} (Analog Operational Parameters)

This EF includes the Extended Address bit (Exp), the Local Use Mark (LCM) and the Group ID (GID) field.

Identifier: '6F26'		Structure: transparent		Mandatory	
File size: 1 byte			Update activity: low		
Access Conditions:					
READ		CHV1			
UPDATE		CHV1			
INVALIDATE		ADM			
REHABILITATE		ADM			
Bytes	Description			M/O	Length
1	Analog Operational Parameters (Exp, LCM, GID)			M	1 byte

Coding:
Byte 1:

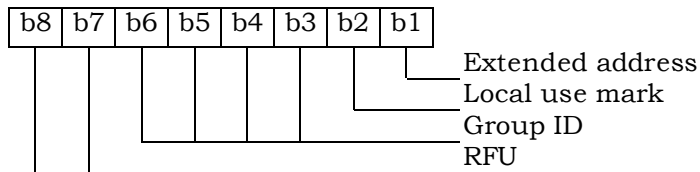

3.4.7 EF_{ALoc} (Analog Location and Registration Indicators)

This EF stores parameters related to Autonomous Registration memory (NXTREG_{s-p} and SID_{s-p}) as well as the Location Area memory (LOCAID_{s-p} and PUREG_{s-p}).

Identifier: '6F27'		Structure: transparent		Mandatory	
File size: 7 bytes			Update activity: high		
Access Conditions:					
READ		CHV1			
UPDATE		CHV1			
INVALIDATE		ADM			
REHABILITATE		ADM			
Bytes	Description			M/O	Length
1-3	NXTREG _{s-p}			M	3 bytes
4-5	SID _{s-p}			M	2 bytes
6-7	LOCAID _{s-p} , PUREG _{s-p}			M	2 bytes

Coding:

Byte 1:

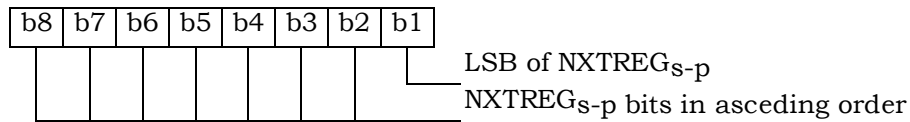

Byte 2:

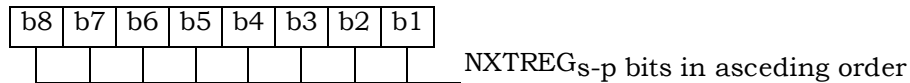

Byte 3:

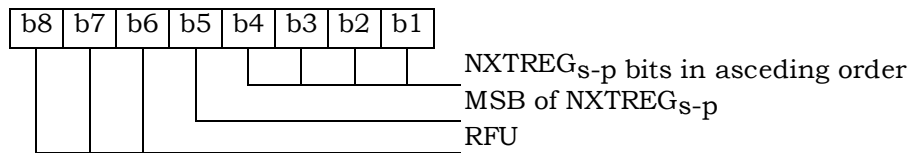

Byte 4:

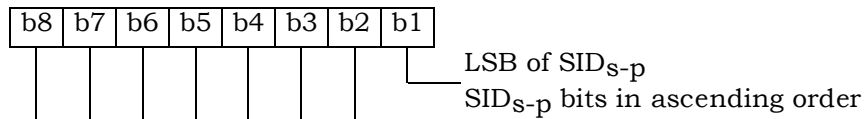

Byte 5:

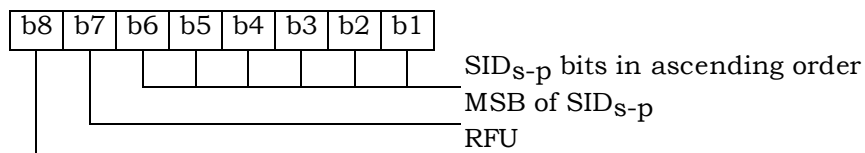

1

Byte 6:

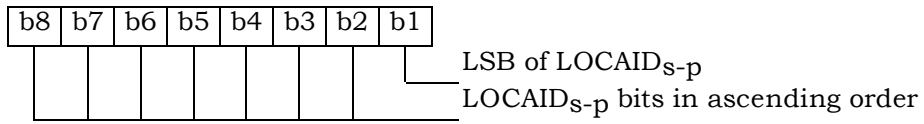

2

3

Byte 7:

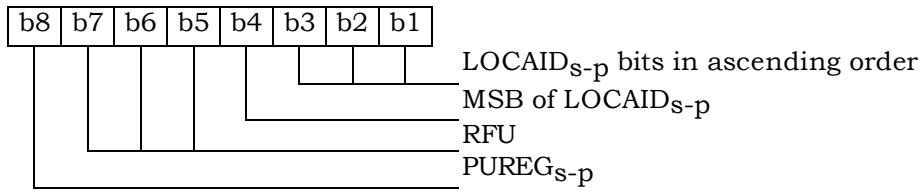

4

3.4.8 EF_{CDMAHOME} (CDMA Home SID, NID)

This EF identifies the home SID and NID when the mobile station is operating in the CDMA mode.

Identifier: '6F28'		Structure: linear fixed		Mandatory
Record length: 5 bytes			Update activity: low	
Access Conditions:				
READ		CHV1		
UPDATE		CHV1		
INVALIDATE		ADM		
REHABILITATE		ADM		
Bytes	Description	M/O	Length	
1 - 2	CDMA Home SID (SID _p)	M	2 bytes	
3 - 4	CDMA Home NID (NID _p)	M	2 bytes	
5	Band Class	M	1 byte	

Coding:

Byte 1:

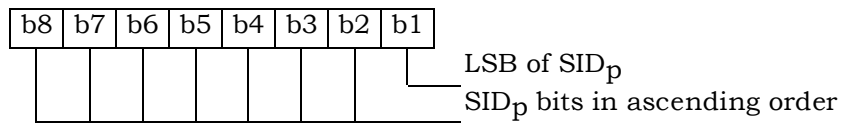

Byte 2:

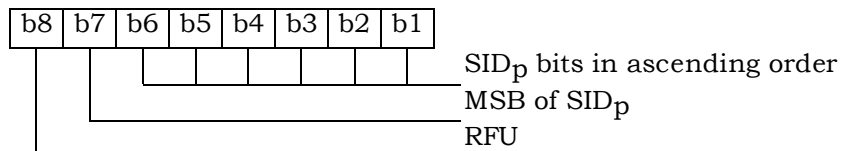

Byte 3:

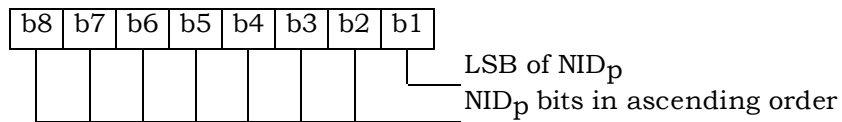

Byte 4:

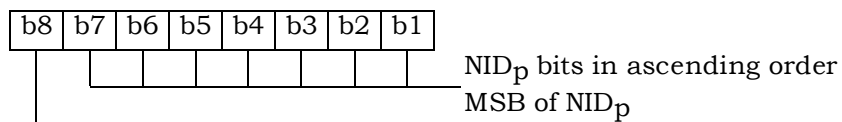

Byte 5:

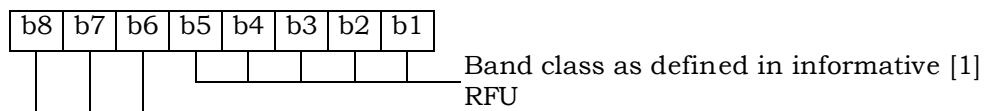

3.4.9 EF_{ZNREGI} (CDMA Zone-Based Registration Indicators)

This EF stores the zone-based registration list “ZONE_LIST”. The list includes a REG_ZONE and a corresponding SID, NID pair. Details are described in sections titled “Registration Memory”, “Zone-Based Registration” and “Registration Procedures” of [5/14].

Identifier: ‘6F29’		Structure: linear fixed		Mandatory
Record length: 8 bytes			Update activity: high	
Access Conditions:				
READ		CHV1		
UPDATE		CHV1		
INVALIDATE		ADM		
REHABILITATE		ADM		
Bytes	Description	M/O	Length	
1 – 2	REG_ZONE	M	2 bytes	
3 – 4	SID	M	2 bytes	
5 – 6	NID	M	2 bytes	
7 – 8	RFU	M	2 bytes	

Coding:

Byte 1:

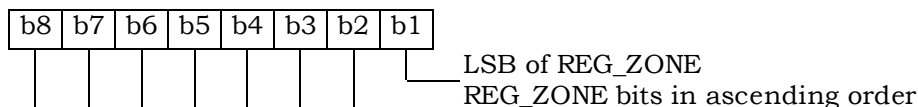

Byte 2:

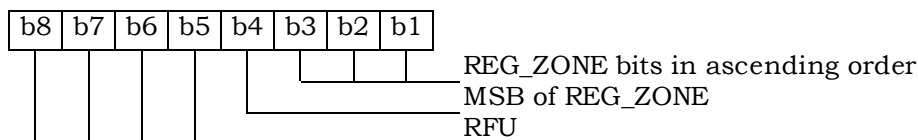

Byte 3:

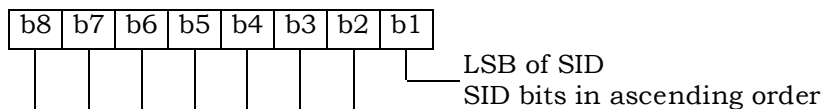

Byte 4:

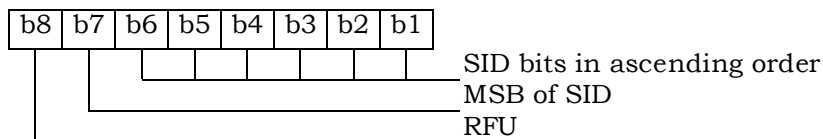

1

Byte 5:

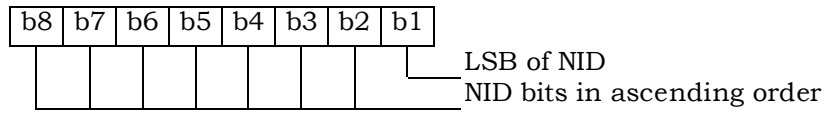

2

3

Byte 6:

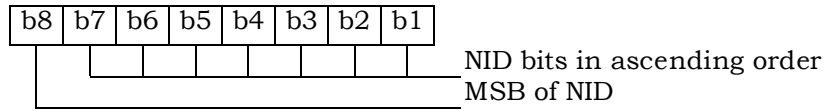

4

5

3.4.10 EF_{SNREGI} (CDMA System-Network Registration Indicators)

This EF stores the SID and NID of the wireless system in which the mobile station last registered. This is described in sections of [14] titled “Registration Memory” and “Zone-Based Registration”, respectively.

Identifier: '6F2A'		Structure: transparent		Mandatory	
File size: 7 bytes			Update activity: high		
Access Conditions:					
READ		CHV1			
UPDATE		CHV1			
INVALIDATE		ADM			
REHABILITATE		ADM			
Bytes	Description	M/O	Length		
1	N, size of SID/NID list (N=1)	M	1 byte		
2 - 3	SID	M	2 bytes		
4 - 5	NID	M	2 bytes		
6 - 7	RFU	M	2 bytes		

Coding:

Byte 1:

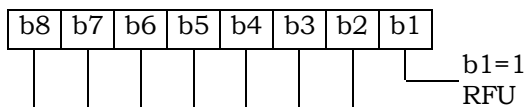

Byte 2:

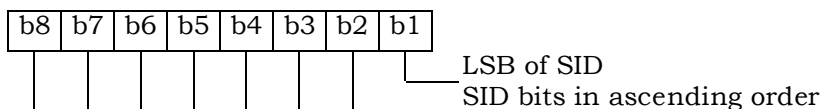

Byte 3:

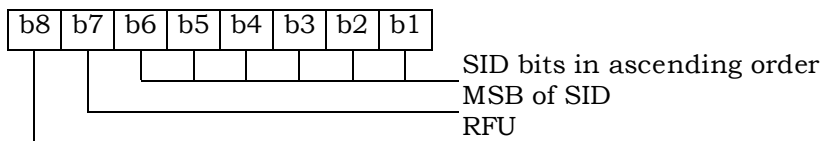

Byte 4:

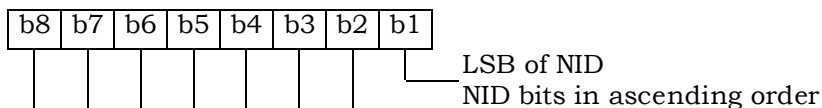

1

Byte 5:

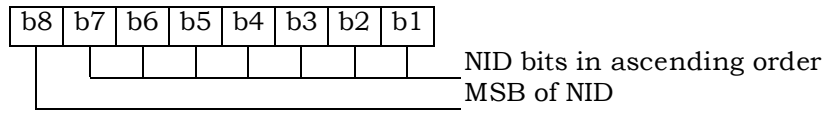

2

3

3.4.11 EF_{DISTREGI} (CDMA Distance-Based Registration Indicators)

This EF stores the Base Station Latitude (BASE_LAT_REG), the Base Station Longitude (BASE_LONG_REG) and the Registration Distance (REG_DIST_REG) of the base station to which the first access probe (for a Registration Message, Origination Message or Page Response Message) was transmitted after entering the System Access State.

Identifier: '6F2B'		Structure: transparent		Mandatory	
File size: 8 bytes			Update activity: high		
Access Conditions:					
READ		CHV1			
UPDATE		CHV1			
INVALIDATE		ADM			
REHABILITATE		ADM			
Bytes	Description	M/O	Length		
1-3	BASE_LAT_REG	M	3 bytes		
4-6	BASE_LONG_REG	M	3 bytes		
7-8	REG_DIST_REG	M	2 bytes		

Coding:

Byte 1:

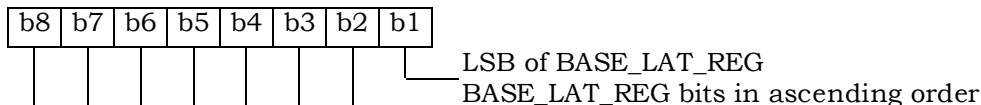

Byte 2:



Byte 3:

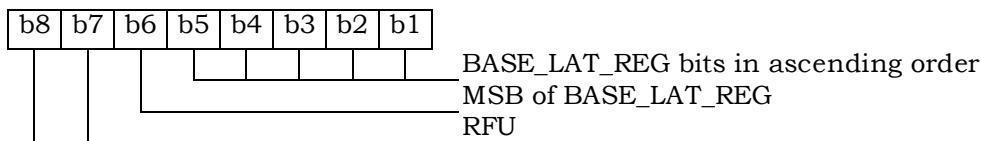

Byte 4:

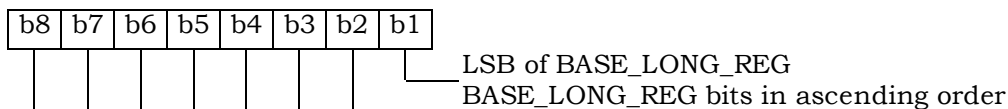

Byte 5:



1
2
3
4
5
6
7
8
9

Byte 6:

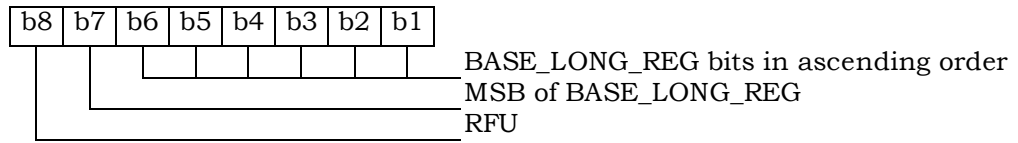

Byte 7:

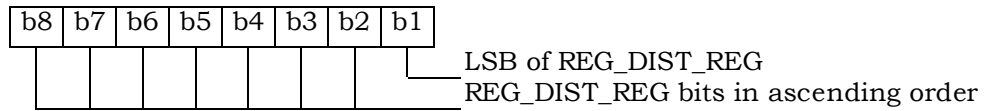

Byte 8:

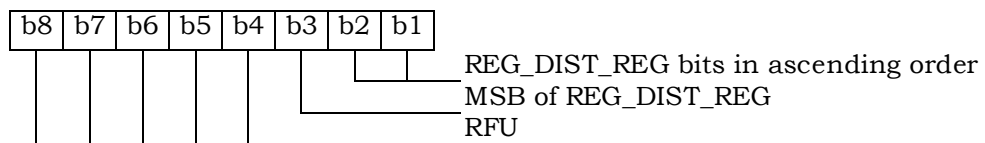

NOTE: The parameters for Distance-Based Registration are described in [14], Section 6.6.5.1.4.

3.4.12 EF_{ACCOLC} (Access Overload Class ACCOLC_p)

This EF defines the access overload class for the mobile station. This access overload class identifies which overload class controls access attempts by the mobile station and is used to identify redirected overload classes in global service redirection. For normal mobile stations, the 4-bit access overload class indicator is derived from the last digit of the associated decimal representation of the IMSI_M via decimal to binary conversion as specified in [5] and [14].

Identifier: '6F2C'		Structure: transparent		Mandatory	
File size: 1 byte			Update activity: low		
Access Conditions:					
READ		CHV1			
UPDATE		ADM			
INVALIDATE		ADM			
REHABILITATE		ADM			
Bytes	Description			M/O	Length
1	Access overload class (ACCOLC _p)			M	1 byte

Coding:
Byte 1:

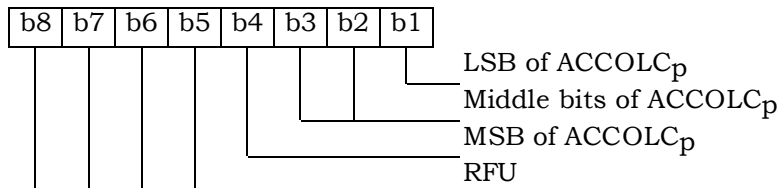

1 3.4.13 EF_{TERM} (Call Termination Mode Preferences)

2 This EF contains the call termination preference MOB_TERM_HOME_p, MOB_TERM_SID_p
 3 and MOB_TERM_FOR_NID_p.

4

Identifier: '6F2D'		Structure: transparent		Mandatory	
File size: 1 byte			Update activity: low		
Access Conditions:					
READ		CHV1			
UPDATE		CHV1			
INVALIDATE		ADM			
REHABILITATE		ADM			
Bytes	Description			M/O	Length
1	Call termination preferences			M	1 byte

5

6 Coding:

6

7 Byte 1:

7

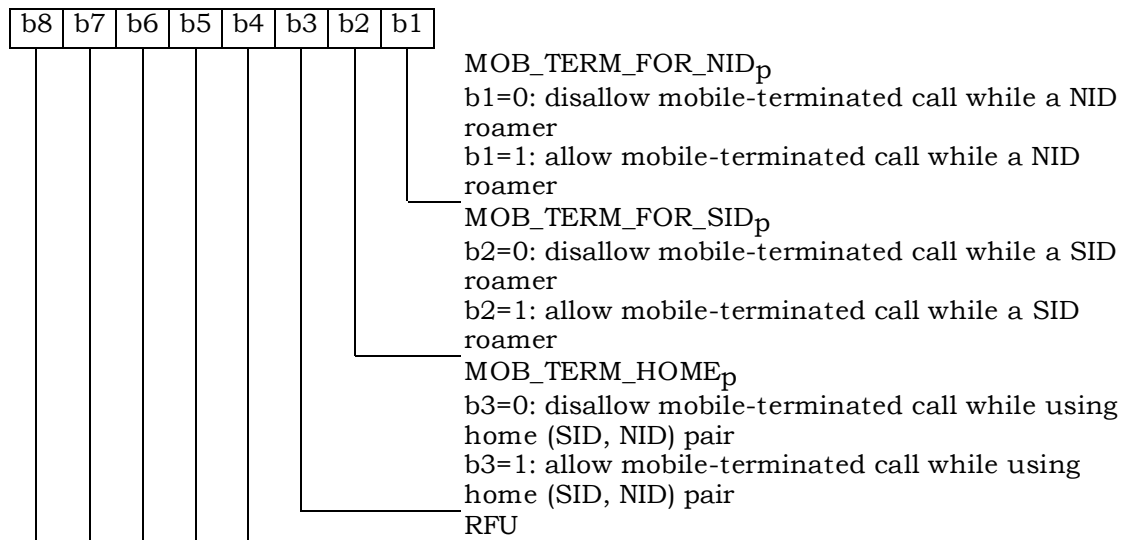

8

3.4.14 EF_{ssci} (Suggested Slot Cycle Index)

This EF suggests a value for the mobile station's preferred slot cycle index for CDMA operation (see 6.3.11 of [14]). Since the mobile equipment may not support all the slot cycle indexes, the mobile equipment shall select the minimum, as the preferred slot cycle index defined in [5], between the slot cycle index supported by the mobile equipment and the suggested slot cycle index contained in the EF_{ssci}.

Identifier: '6F2E'		Structure: transparent		Optional	
File size: 1 byte			Update activity: low		
Access Conditions:					
READ		CHV1			
UPDATE		CHV1			
INVALIDATE		ADM			
REHABILITATE		ADM			
Bytes	Description			M/O	Length
1	Suggested slot cycle index			M	1 byte

Coding:
Byte 1:

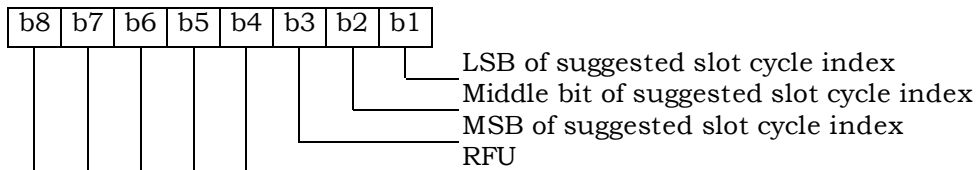

3.4.15 EF_{ACP} (Analog Channel Preferences)

This EF specifies the analog mode channel preferences as determined by the service provider in accordance with the terms of the subscription. The items addressed are the Analog Initial Paging Channel, the Analog First Dedicated Control Channel for System A, the Analog First Dedicated Control Channel for System B, and the Number of Dedicated Control Channels to scan.

Identifier: '6F2F'		Structure: transparent		Mandatory
File size: 7 bytes			Update activity: low	
Access Conditions:				
READ		CHV1		
UPDATE		CHV1		
INVALIDATE		ADM		
REHABILITATE		ADM		
Bytes	Description	M/O	Length	
1-2	Analog Initial Paging Channel	M	2 bytes	
3-4	Analog First Dedicated Control Channel System A	M	2 bytes	
5-6	Analog First Dedicated Control Channel System B	M	2 bytes	
7	Number of Dedicated Control Channel to Scan	M	1 byte	

NOTE: Each channel is represented by an 11-bit binary number.

Coding:

Byte 1, 3, 5:

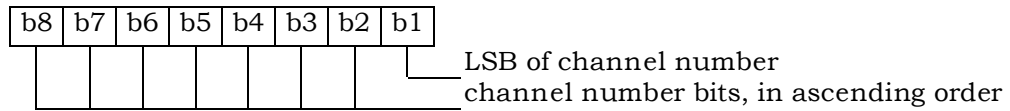

Byte 2, 4, 6:

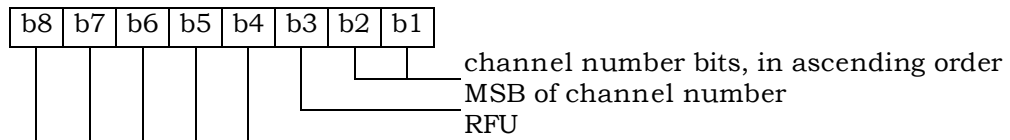

1 3.4.16 EF_{PRL} (Preferred Roaming List)

2 This EF stores the Preferred Roaming List, as described in Section 3.5.3 of [7]. The
 3 Preferred Roaming List includes selection parameters from [5] and [14].

4

Identifier: '6F30'		Structure: transparent		Mandatory	
File size: 'MAX_PR_LIST_SIZE'			Update activity: low		
Access Conditions:					
READ		CHV1			
UPDATE		ADM			
INVALIDATE		ADM			
REHABILITATE		ADM			
Bytes	Description		M/O	Length	
1- PR_LIST_ SIZE	PR_LIST (see Section 3.5.5 of [7])		M	PR_LIST_SIZE	

5

1 3.4.17 EF_{RUIMID} (Removable UIM_ID)

2 This EF stores a 32-bit electronic identification number (ID) unique to the R-UIM or a 32-
 3 bit pseudo-UIMID of the R-UIM. The file may store a 32-bit pseudo-UIMID constructed in
 4 the following way: The most significant 8 bits shall be 0x 80. The least significant 24 bits
 5 shall be the 24 least significant bits of SHA-1 digest of the entire EUIMID, either
 6 LF_EUIMID or SF_EUIMID² (based on n8 in CDMA service table)-) ³.
 7

Identifier: '6F31'		Structure: transparent		Mandatory	
File size: 8 bytes			Update activity: low		
Access Conditions:					
READ		ALW			
UPDATE		Never			
INVALIDATE		Never			
REHABILITATE		Never			
Bytes	Description	M/O	Length		
1	Number of bytes	M	1 byte		
2	Lowest-order byte	M	1 byte		
3	:	M	1 byte		
4	:	M	1 byte		
5	:	M	1 byte		
6	:	O	1 byte		
7	:	O	1 byte		
8	Highest-order byte	O	1 byte		

8

² Example: if the ~~56-bit SFLF_EUIMID (ICCID)~~ is (hexadecimal) ~~FF-00-0089 (MSB) 01 12-34-5601 01 23 45 67 89 01 4F (LSB)~~, the pseudo-UIMID is (hexadecimal) 80 (Byte 5) 7D ED 89 (Byte 2), and with Byte 1 set to 04; if the 56-bit SF_EUIMID is (hexadecimal) FF (MSB) 00 00 01 12 34 56 (LSB), the pseudo-UIMID is (hexadecimal) 80 (Byte 5) 07 37 E1-(Byte 2), and with Byte 1 set to 04.

³ The EUIMID (either form) is loaded into a 512-bit SHA-1 input block, starting with bit 1 of this block, to produce an output, from which the least significant 24 bits are used as the least significant 24 bits of EF(RUIMID). The 4-bit digits of EUIMID are loaded in the order d1, d2, d3, d4...dn-1, dn. For each digit the least significant bit is loaded into the highest numbered of four consecutive SHA-1 input bits and the most significant bit into the lowest.

3.4.18 EF_{csr} (CDMA Service Table)

This EF indicates which services are allocated, and whether, if allocated, the service is activated. If a service is not allocated or not activated in the R-UIM, the mobile equipment (ME) shall not select this service.

Identifier: '6F32'		Structure: transparent		Mandatory
File size: N bytes		Update activity: low		
Access Conditions:				
READ		CHV1		
UPDATE		ADM		
INVALIDATE		ADM		
REHABILITATE		ADM		
Bytes	Description	M/O	Length	
1	Services n1 to n4	M	1 byte	
2	Services n5 to n8	M	1 byte	
3	Services n9 to n12	M	1 byte	
4	Services n13 to n16	M	1 byte	
5	Services n17 to n20	M	1 byte	
:	:	:	:	
N	Services (4n-3) to (4n)	O	1 byte	

Services:

Service n1 :	CHV disable function
Service n2 :	Abbreviated Dialing Numbers (ADN)
Service n3 :	Fixed Dialing Numbers (FDN)
Service n4 :	Short Message Storage (SMS)
Service n5 :	HRPD
Service n6 :	Enhanced Phone Book
Service n7 :	Multi Media Domain (MMD)
Service n8 :	SF_EUIMID-based EUIMID
Service n9 :	MEID Support
Service n10 :	Extension1
Service n11 :	Extension2
Service n12 :	SMS Parameters
Service n13 :	Last Number Dialed (LND)
Service n14 :	Service Category Program for BC-SMS
Service n15 :	RFU
Service n16 :	RFU
Service n17 :	CDMA Home Service Provider Name
Service n18 :	Service Dialing Numbers (SDN)
Service n19 :	Extension3
Service n20 :	3GPD-SIP
Service n21 :	RFU
Service n22 :	RFU
Service n23 :	RFU
Service n24 :	RFU
Service n25 :	Data Download via SMS Broadcast
Service n26 :	Data Download via SMS-PP
Service n27 :	Menu Selection
Service n28 :	Call Control
Service n29 :	Proactive R-UIM
Service n30 :	AKA
Service n31 :	RFU
Service n32 :	RFU
Service n33 :	RFU
Service n34 :	RFU
Service n35 :	RFU
Service n36 :	RFU
Service n37 :	RFU
Service n38 :	3GPD-MIP
Service n39 :	BCMCS
Service n40 :	Multimedia Messaging Service (MMS)
Service n41 :	Extension 8
Service n42 :	MMS User Connectivity Parameters
Service n43 :	Application Authentication
Service n44 :	Group Identifier Level 1
Service n45 :	Group Identifier Level 2
Service n46 :	De-Personalization Control Keys
Service n47 :	Cooperative Network List

1
2
3

NOTE: Additional services, when defined, will be coded on further bytes in the EF.

Coding:

Each byte is used to code 4 services.
 2 bits are used to code each service:
 first bit = 1: service allocated
 first bit = 0: service not allocated
 where the first bit is b1, b3, b5 or b7;
 second bit = 1: service activated
 second bit = 0: service not activated
 where the second bit is b2, b4, b6 or b8.

“Service allocated” means that the R-UIM has the capability to support the service.
 “Service activated” means that the service is available.

Service delivery can only occur when service is allocated, service is activated and the R-UIM is operating in an environment that supports delivery of the service.

The following codings are possible:

- first bit = 0: service not allocated, second bit has no meaning;
- first bit = 1 and second bit = 0: service allocated but not activated;
- first bit = 1 and second bit = 1: service allocated and activated.

The bits for services not yet defined shall be set to RFU. All bytes that are RFU shall be set to ‘00’ and RFU bits will be set to ‘0’.

Byte 1:

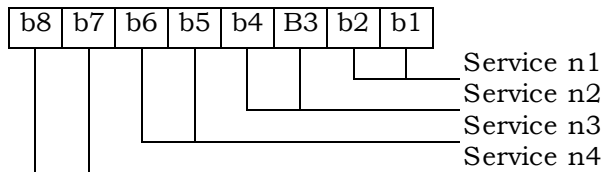

Byte 2:

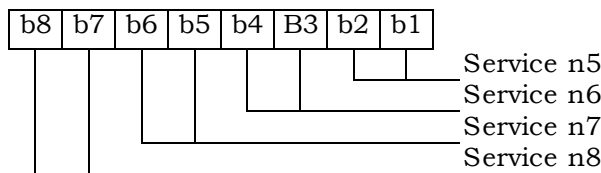

Etc.

If the R-UIM supports the FDN feature (FDN allocated and activated) a special mechanism shall exist in the R-UIM which invalidates EF_{IMSI_T} , EF_{IMSI_M} and EF_{TMSI} once during each CDMA session. This mechanism shall be invoked by the R-UIM automatically if FDN is enabled. This invalidation shall occur at least before the next command following selection of either EF_{FDN} is enabled when the ADN is invalidated or not activated.

If service n8 (SF_EUIMID-based EUIMID) is not activated (either allocated or not), ME shall fill in EUIMEXT_UIM_ID INFO RECORD with ~~ICCID~~ *from the entire contents of* EF_{ICCID} in response to *Status Request Message* defined in [5]. Otherwise, ME shall fill in EUIMEXT_UIM_ID INFO RECORD with SF_EUIMID from $EF_{\text{SF_EUIMID}}$.

3.4.19 EF_{SPC} (Service Programming Code)

This EF includes the Service Programming Code (SPC), having a value from 0 to 999,999. The default value is 0. Details of SPC are in [7], section 3.3.6.

Identifier: '6F33'		Structure: transparent		Mandatory	
File size: 3 bytes			Update activity: low		
Access Conditions:					
READ		ADM			
UPDATE		ADM			
INVALIDATE		ADM			
REHABILITATE		ADM			
Bytes	Description	M/O	Length		
1-3	Service Programming Code	M	3 bytes		

Coding:

SPC is a 6-digit number $D_1D_2D_3D_4D_5D_6$, where D_1 is the most significant digit and D_6 is the least significant digit. The coding of SPC in this EF is according to [7], section 4.5.4.2, whereby each digit is encoded in BCD format.

Byte 1:

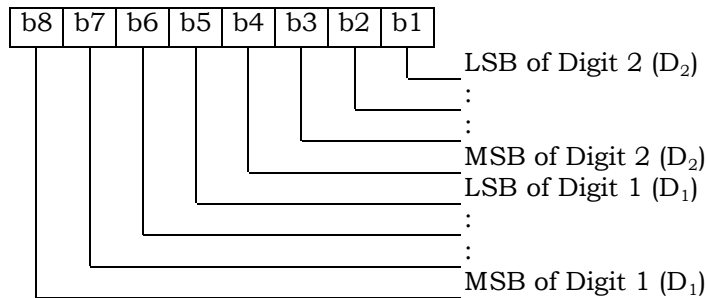

Byte 2:

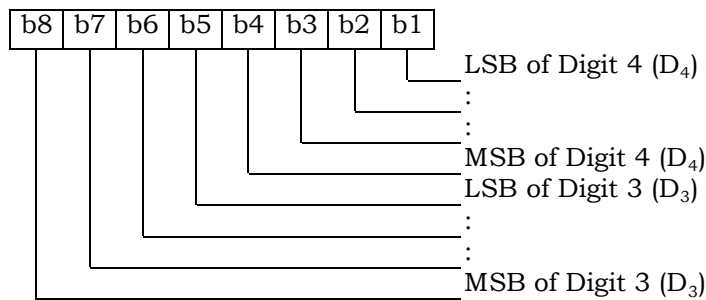

1

Byte 3:

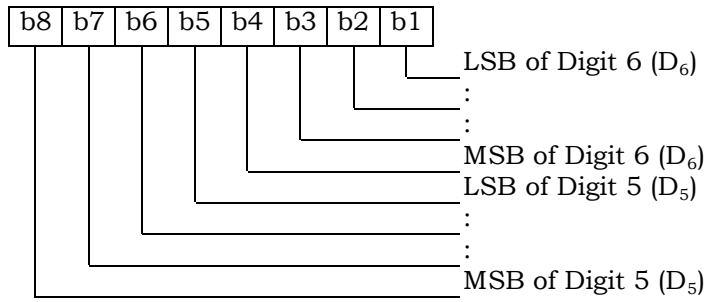

2

1 3.4.20 EF_{OTAPASPC} (OTAPA/SPC_Enable)

2 This EF contains user-entered control information that either prevents or (else) permits
 3 network manipulation of the SPC, and either prevents or (else) permits OTAPA to be
 4 performed on the NAM. This EF is based upon information in [7], sections 3.2.2 and 3.3.6.
 5 A successful base station response to an R-UIM initiated challenge is required prior to any
 6 network manipulation of OTAPA accessible files.
 7

Identifier: '6F34'		Structure: transparent		Mandatory	
File size: 1 byte			Update activity: low		
Access Conditions:					
READ		CHV1			
UPDATE		CHV1			
INVALIDATE		ADM			
REHABILITATE		ADM			
Bytes	Description			M/O	Length
1	OTAPA/SPC_Enable			M	1 byte

8 Coding:
 9 Byte 1:

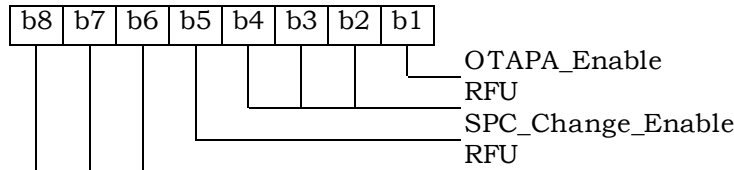

11
 12 For OTAPA_Enable, a value of '0' for the NAM indicates that the user consents to the
 13 performance of OTAPA for the NAM by the service provider. A value of '1' indicates that
 14 the user does not permit OTAPA be to performed on the NAM. Refer to [7], Section 3.2.2.

15 For SPC_Change Enable, a value of '0' for the R-UIM indicates that the user consents to
 16 allow the service provider to change the value of the Service Programming Code. A value
 17 of '1' indicates that the user denies permission for the service provider to change the value
 18 of SPC.
 19

3.4.21 EF_{NAMLOCK} (NAM_LOCK)

This EF stores the locked/unlocked state of the NAM. This EF is based upon information in [7].

Identifier: '6F35'		Structure: transparent		Mandatory	
File size: 1 byte			Update activity: low		
Access Conditions:					
READ		CHV1			
UPDATE		CHV1			
INVALIDATE		ADM			
REHABILITATE		ADM			
Bytes	Description			M/O	Length
1	SPASM protection indicator (NAM_LOCK) status			M	1 byte

Coding:
Byte 1:

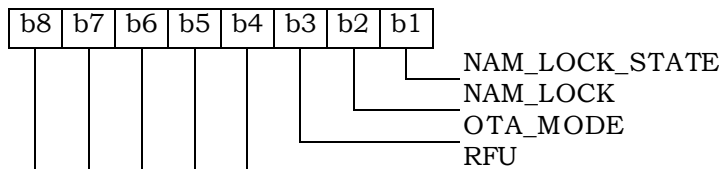

Bit 1 gives the current NAM_LOCK_STATE. A value of '1' indicates that the NAM is locked by the SPASM protection mechanism. A value of '0' indicates that the NAM is unlocked.

Bit 2 gives the permanent NAM_LOCK setting. A value of '1' indicates that the SPASM protection mechanism must be satisfied for network initiated OTA. A value of '0' indicates that SPASM protection is not required.

Bit 3 gives the OTA_MODE for the current OTA session. A value of '0' indicates user-initiated, and a value of '1' indicates network-initiated.

If an OTA programming session was initiated by the user as described in Section 3.2.1 of [7], SPASM does not protect access to the NAM parameters and indicators. In this case, the ME shall set the NAM_LOCK_STATE to '0.' The NAM_LOCK bit shall not be changed.

On invocation of a network-initiated OTA session, the ME shall set the NAM_LOCK_STATE=NAM_LOCK.

The ME updates the OTA_MODE bit to tell the R-UIM how an OTA session was initiated. The ME shall set this bit on initiation of an OTA session. The R-UIM shall comply with the requirements in [7] (e.g. shall reject OTAPA Request while in a user-initiated session.)

1 3.4.22 EF_{OTA} (OTASP/OTAPA Features)

2 This EF stores a listing of OTASP/OTAPA features supported by the R-UIM, along with
 3 protocol revision codes. This EF is a subset of the information in [7], section 3.5.1.7.
 4

Identifier: '6F36'		Structure: transparent		Mandatory	
File size: 2N + 1 bytes			Update activity: low		
Access Conditions:					
READ		CHV1			
UPDATE		ADM			
INVALIDATE		ADM			
REHABILITATE		ADM			
Bytes	Description	M/O	Length		
1	N, number of OTASP/OTAPA features	M	1 byte		
2	NAM Download (DATA_P_REV) ID	M	1 byte		
3	DATA_P_REV	M	1 byte		
4	Key Exchange (A_KEY_P_REV) ID	M	1 byte		
5	A_KEY_P_REV	M	1 byte		
6	System Selection for Preferred Roaming (SSPR_P_REV) ID	M	1 byte		
7	SSPR_P_REV	M	1 byte		
8	Service Programming Lock (SPL_P_REV) ID	M	1 byte		
9	SPL_P_REV	M	1 byte		
10	Over-The-Air Parameter Admin (OTAPA_P_REV) ID	M	1 byte		
11	OTAPA_P_REV	M	1 byte		
12	Preferred User Zone List (PUZL_P_REV) ID	M	1 byte		
13	PUZL_P_REV	M	1 byte		
14	3G Packet Data (3GPD) ID	M	1 byte		
15	3GPD	M	1 byte		
16	Secure MODE (SECURE_MODE_P_REV) ID	M	1 byte		
17	SECURE_MODE_P_REV	M	1 byte		
:	:	:	:		
2N	Feature N	M	1 byte		
2N + 1	Protocol Revision for Feature N	M	1 byte		

5
 6 NOTE: Coding of features and protocol revisions are described in [7], section 3.5.1.7.
 7

3.4.23 EF_{sp} (Service Preferences)

This EF describes the user's service preferences as defined in [14] Sections 6.3.10.1 and 6.3.10.2.

Identifier: '6F37'		Structure: transparent		Mandatory	
File size: 1 byte			Update activity: low		
Access Conditions:					
READ		CHV1			
UPDATE		CHV1			
INVALIDATE		ADM			
REHABILITATE		ADM			
Bytes	Description	M/O	Length		
1	Service Preferences (e.g. band class, analog vs. CDMA)	M	1 byte		

Coding:
Byte 1:

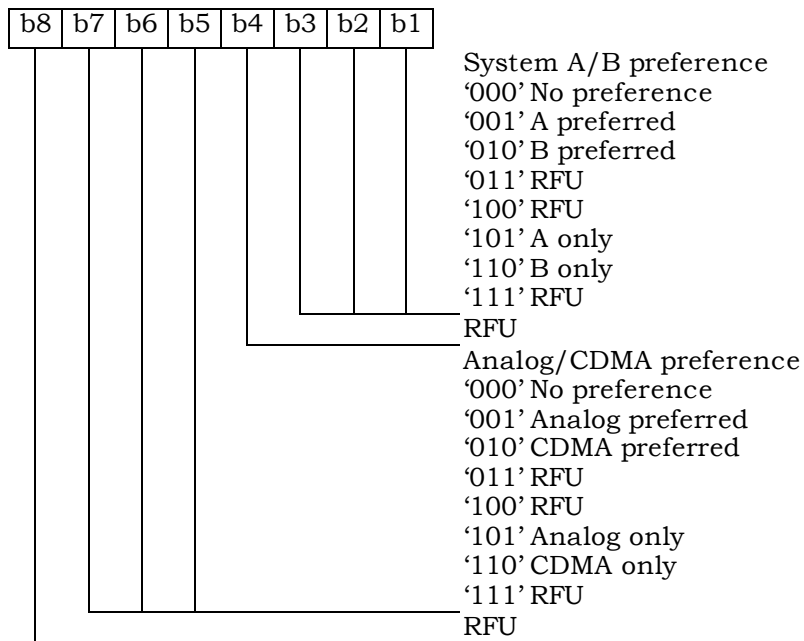

1 3.4.24 EF_{ESNME} (ESN_ME)

2 This EF stores the ~~(up to)~~ 56-bit Electronic Serial Number or 56-bit MEID or pseudo-ESN
 3 of the Mobile Equipment (ME) to which the R-UIM is attached. This number is transferred
 4 to the R-UIM when the Mobile Equipment determines that the R-UIM has been inserted.
 5

Identifier: '6F38'		Structure: transparent		Mandatory	
File size: 8 bytes			Update activity: low		
Access Conditions:					
READ		ALW			
UPDATE		ADM			
INVALIDATE		ADM			
REHABILITATE		ADM			
Bytes	Description	M/O	Length		
1	Number of bytes for ESN_ME	M	1 byte		
2	Lowest-order byte	M	1 byte		
3	:	M	1 byte		
4	:	M	1 byte		
5	:	M	1 byte		
6	:	M	1 byte		
7	:	M	1 byte		
8	Highest-order byte	M	1 byte		

6

7

3.4.25 EF_{Revision} (R-UIM Revision)

This EF allows the ME to communicate with different versions of the R-UIM (i.e. R-UIM with different set of capabilities).

Identifier: '6F39'		Structure: transparent		Mandatory	
File size: 1 byte			Update activity: low		
Access Conditions:					
READ		ALW			
UPDATE		ADM			
INVALIDATE		ADM			
REHABILITATE		ADM			
Bytes	Description			M/O	Length
1	R-UIM Revision			M	1 byte

Coding:
Byte 1:

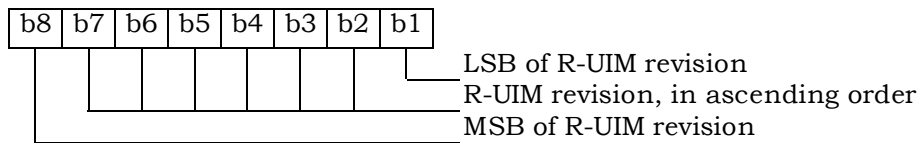

An R-UIM complying with this specification shall set the R-UIM revision to '00000011'.

1 3.4.26 EF_{PL} (Preferred Languages)

2 This EF assists the ME in offering a set of different languages (i.e. English, German,
 3 French, Japanese, etc.). From this set of languages, the user can choose to have the
 4 information displayed in the desired language.
 5

Identifier: '6F3A'		Structure: transparent		Mandatory
File size: 2N bytes			Update activity: low	
Access Conditions:				
READ		ALW		
UPDATE		CHV1		
INVALIDATE		ADM		
REHABILITATE		ADM		
Bytes	Description	M/O	Length	
1 - 2	1 st language code (highest priority)	M	2 bytes	
3 - 4	2 nd language code	O	2 bytes	
:	:	:	:	
2N-1 - 2N	N th language code (lowest priority)	O	2 bytes	

6

7 Coding:

8

Byte 1:

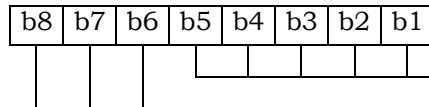

Character Encoding as defined in informative [1].
 RFU

9

10

Byte 2:

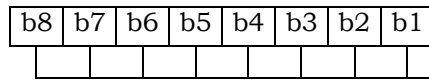

Language Indicator as defined in informative [1].

11

3.4.27 EF_{SMS} (Short Messages)

This EF contains information in accordance with [8] comprising short messages (and associated parameters) which have either been received by the MS from the network or are to be used as an MS originated message.

Identifier: '6F3C'		Structure: linear fixed		Optional	
Record Length: variable (1)			Update activity: high		
Access Conditions:					
READ		CHV1			
UPDATE		CHV1			
INVALIDATE		ADM			
REHABILITATE		ADM			
Bytes	Description	M/O	Length		
1	Status	M	1 byte		
2	MSG_LEN	M	1 byte		
3 – 3+MSG_L EN	SMS Transport Layer Message	M	MSG_LEN bytes		

Note: (1) The length and the byte allocations are variable according to the actual size of the SMS Transport Layer message. The maximum length is 255, which includes the length of the short message plus two bytes for storing "status" and "MSG_LEN".

- Status
Status byte of the record which can be used as a pattern in the SEEK command. For MS originating messages sent to the network, the status shall be updated when the MS receives a status report or sends a successful SMS Command relating to the status report.

1
2

3
4
5
6
7
8
9
10
11
12
13
14
15

Coding:
Byte 1:

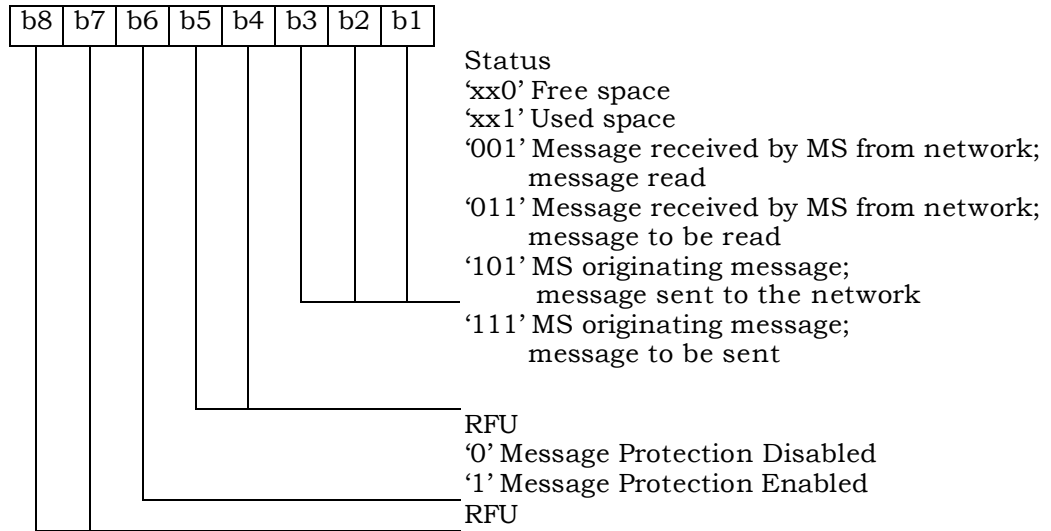

- MSG_LEN
The length of the message not including MSG_LEN. Note that the definition of this EF does allow multiple occurrences of the segment, which consists of "PARAMETER_ID", "PARAMETER_LEN", and "Parameter Data" as described in [8]. The number of repetitions of the aforementioned segment is determined by MSG_LEN and the PARAMETER_LEN of each segment.

- SMS Transport Layer Message
Contents: see Section 3.4.1 of [8].

1 3.4.28 EF_{SMSP} (Short Message Service Parameters)

2 This EF contains values for Short Message Service header Parameters (SMSP), which can
3 be used by the Mobile Equipment (ME) for user assistance in preparation of mobile
4 originated short messages.

5 The EF consists of one or more records, with each record able to hold a set of SMS
6 parameters. The first (or only) record in the EF shall be used as a default set of
7 parameters, if no other record is selected. To distinguish between records, a four-byte
8 Teleservice Identifier as defined in [8] shall be included within each record. The SMS
9 parameters stored within a record may be present or absent independently. When a short
10 message is to be sent from the Mobile Station (MS), the parameters in the R-UIM record, if
11 present, shall be used when a value is not supplied by the user.
12

Identifier: '6F3D'		Structure: linear fixed		Optional
Record Length: variable		Update activity: high		
Access Conditions:				
READ		CHV1		
UPDATE		CHV1		
INVALIDATE		ADM		
REHABILITATE		ADM		
Bytes	Description	M/O	Length	
(1), (2)	Teleservice Identifier	M	4 bytes	
	Parameter Indicators	M	2 bytes	
	Reserved	M	1 byte	
	Destination Address	M	Variable (1)(3)	
	MSG_ENCODING	M	1 byte	
	Validity Period	M	1 byte	
	Service Category	O	4 bytes	
	Destination Subaddress	O	Variable (1)	
	Bearer Reply Option	O	3 bytes	
	Bearer Data	O	Variable (1)	

- 13
14 Notes: (1) See [8].
15 (2) Starting and ending bytes depend on (1)
16 (3) If the Destination Address is absent, the parameter length is 1 byte.
17

18 Storage is allocated for all of the possible SMS parameters, regardless of
19 whether they are present or absent. Any bytes unused, due to parameters not
20 requiring all of the bytes, or due to absent parameters, shall be set to 'FF'.

21 The supported teleservices include [16] Extended Protocol Enhanced Services,
22 Wireless Paging Teleservice, Wireless Messaging Teleservice, Voice Mail Notification
23 and Wireless Application Protocol. See [8] for details.

24
25 - Parameter Indicators

26 Contents:

27 Each of the default SMS parameters which can be stored in the remainder of the
28 record are marked absent or present by individual bits within this byte.

Coding:
Byte 5:

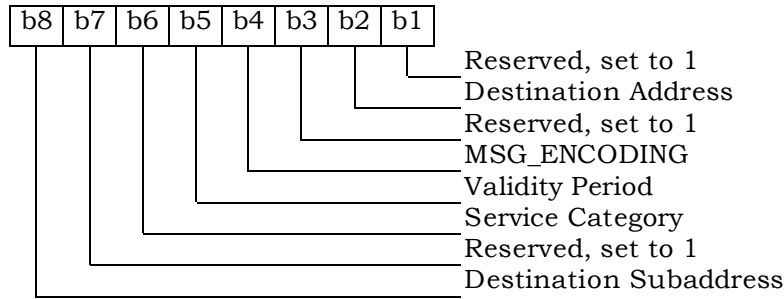

Byte 6:

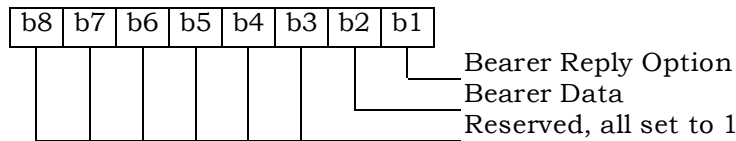

Note: Bit value 0 means parameter present
Bit value 1 means parameter absent

- Destination Address
Contents and Coding: as defined in [8]. If this parameter is absent, then it shall be set to 'FF' with a length of 1 byte.
- MSG_ENCODING
Contents: as defined in informative [1]. This parameter can appear in the Bearer Data if Bearer Data is present. If this parameter appears in the Bearer Data too, then the same value shall be set to this parameter; otherwise the record is invalid. If this parameter appears in the Bearer Data, then this parameter shall be present; otherwise the record is invalid.
Coding:

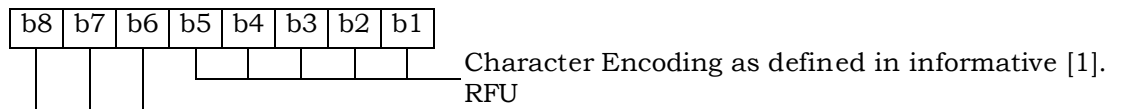

- Validity Period
Contents and Coding: as defined in [8] for relative time format. This parameter can appear in the Bearer Data if Bearer Data is present. If this parameter appears in the Bearer Data too, then the same value shall be set to this parameter; otherwise the record is invalid. If this parameter appears in the Bearer Data, then this parameter shall be present; otherwise the record is invalid.
- Service Category
Contents and Coding: as defined in [8].
- Destination Subaddress
Contents and Coding: as defined in [8].

- 1 - Bearer Reply Option
- 2 Contents and Coding: as defined in [8].
- 3
- 4 - Bearer Data
- 5 Contents and Coding: as defined in [8].
- 6

3.4.29 EF_{SMSS} (SMS Status)

This EF contains status information relating to the short message service.

The provision of this EF is associated with EF_{SMS}. Both files shall be present together or both shall be absent from the R-UIM.

Identifier: '6F3E'		Structure: transparent		Optional	
File size: 5 + X bytes			Update activity: low		
Access Conditions:					
READ		CHV1			
UPDATE		CHV1			
INVALIDATE		ADM			
REHABILITATE		ADM			
Bytes	Description			M/O	Length
1 - 2	MESSAGE_ID			M	2 bytes
3 - 4	WAP MESSAGE_ID			M	2 bytes
5	SMS "Memory Cap. Exceeded" Not. Flag/SMS Timestamp Mode			M	1 byte
6-5 + X	Reserved			O	X bytes

- MESSAGE_ID
Contents: the value of the MESSAGE_ID in the last sent *SMS Submit Message* from a teleservice which requires message identifiers other than the WAP teleservice.
Coding: as defined in [8].
- WAP MESSAGE_ID
Contents: the value of the MESSAGE_ID in the last sent *SMS Submit Message* from the WAP teleservice.
Coding: as defined in [8].
- SMS "Memory Capacity Exceeded" Notification Flag/SMS Timestamp Mode.
Contents: Includes a flag that indicates whether or not there is memory capacity available to store SMS messages. Also includes a bit that indicates whether the SMS Timestamp mode is UTC or non-UTC.
Coding:
Byte 5:

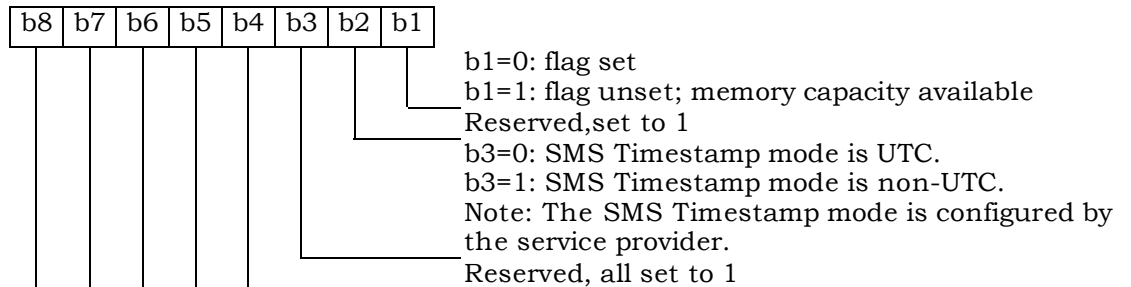

1 3.4.30 EF_{ssfc} (Supplementary Services Feature Code Table)

2 This EF stores the numeric feature code to be used by the ME when a supplementary
3 service is invoked in CDMA or analog mode via an implementation-dependant user
4 interface (such as a menu) that automatically inserts a feature code into the dialed digit
5 string. Because feature codes are service-provider specific, this EF is required to enable
6 the ME to perform the mapping to the feature code.

7 When a supplementary service is invoked in CDMA or analog mode, the mobile station
8 shall determine the feature code by reading the Supplementary Service Feature Code
9 Table entry for the selected supplementary service, and pre-pending with asterisk.
10

Identifier: '6F3F'		Structure: transparent		Optional	
File size: 2N+1			Update activity: low		
Access Conditions:					
READ		CHV1			
UPDATE		CHV1			
INVALIDATE		ADM			
REHABILITATE		ADM			
Bytes	Description	M/O	Length		
1	N, Number of Feature Codes	M	1 byte		
2 – 3	Activate Call Delivery (CD)	M	2 bytes		
4 – 5	De-activate Call Delivery (CD)	M	2 bytes		
6 – 7	Register new Call Forwarding – Busy (CFB) forward-to number	M	2 bytes		
8 – 9	Register Call Forwarding – Busy (CFB) to voice mail	M	2 bytes		
10 – 11	De-register Call Forwarding – Busy (CFB)	M	2 bytes		
12 – 13	Activate Call Forwarding – Busy (CFB)	M	2 bytes		
14 – 15	De-activate Call Forwarding – Busy (CFB)	M	2 bytes		
16 – 17	Register new Call Forwarding – Default (CFD) forward-to number	M	2 bytes		
18 – 19	Register Call Forwarding – Default (CFD) to voice mail	M	2 bytes		
20 – 21	De-register Call Forwarding – Default (CFD)	M	2 bytes		
22 – 23	Activate Call Forwarding – Default (CFD)	M	2 bytes		
24 – 25	De- activate Call Forwarding – Default (CFD)	M	2 bytes		
26 – 27	Register new Call Forwarding – No Answer (CFNA) forward-to number	M	2 bytes		
28 – 29	Register Call Forwarding – No Answer (CFNA) to voice mail	M	2 bytes		
30 – 31	De-register Call Forwarding – No Answer (CFNA)	M	2 bytes		
32 – 33	Activate Call Forwarding – No Answer (CFNA)	M	2 bytes		
34 – 35	De-activate Call Forwarding – No Answer (CFNA)	M	2 bytes		
36 – 37	Register new Call Forwarding – Unconditional (CFU) forward-to number	M	2 bytes		
38 – 39	Register Call Forwarding – Unconditional (CFU) to voice mail	M	2 bytes		
40 – 41	De-register Call Forwarding – Unconditional (CFU)	M	2 bytes		
42 – 43	Activate Call Forwarding – Unconditional (CFU)	M	2 bytes		
44 – 45	De-activate Call Forwarding – Unconditional (CFU)	M	2 bytes		
46 – 47	Activate Call Waiting (CW)	M	2 bytes		
48 – 49	De-activate Call Waiting (CW)	M	2 bytes		
50 – 51	Temporarily De-activate Call Waiting (Cancel Call Waiting - CCW)	M	2 bytes		
52 – 53	Temporarily Activate Calling Number Identification Restriction (CNIR) (per-call blocking)	M	2 bytes		
54 – 55	Temporarily De-activate Calling Number Identification Restriction (CNIR) (per-call allowed)	M	2 bytes		
56 – 57	Invoke Conference Calling (CC)	M	2 bytes		
58 – 59	Invoke Drop Last Conference Calling (CC) Party	M	2 bytes		
60 – 61	Activate Do Not Disturb (DND)	M	2 bytes		

62 – 63	De-activate Do Not Disturb (DND)	M	2 bytes
64 – 65	Activate Message Waiting Notification (MWN) Alert Pip Tone	M	2 bytes
66 – 67	De-activate Message Waiting Notification (MWN) Alert Pip Tone	M	2 bytes
68 – 69	Activate Message Waiting Notification (MWN) Pip Tone	M	2 bytes
70 – 71	De-activate Message Waiting Notification (MWN) Pip Tone	M	2 bytes
72 – 73	Temporarily De-activate Message Waiting Notification (MWN) Pip Tone (Cancel MWN - CMWN)	M	2 bytes
74 – 75	Invoke Priority Access and Channel Assignment (PACA)	M	2 bytes
76 – 77	Invoke Voice Message Retrieval (VMR)	M	2 bytes
78 – 79	Activate Calling Name Presentation (CNAP)	M	2 bytes
80 – 81	De-activate Calling Name Presentation (CNAP)	M	2 bytes
82 – 83	Activate Calling Name Restriction (CNAR)	M	2 bytes
84 – 85	De-activate Calling Name Restriction (CNAR)	M	2 bytes
86 – 87	Activate Automatic Callback (AC)	M	2 bytes
88 – 89	De-activate Automatic Callback (AC)	M	2 bytes
90 – 91	Activate Automatic Recall (AR)	M	2 bytes
92 – 93	De-activate Automatic Recall (AR)	M	2 bytes
94 – 95	Register new network registered User Selectable Call Forwarding (USCF) directory number	M	2 bytes
96 – 97	Activate Rejection of Undesired Annoying Calls (RUAC)	M	2 bytes
98 – 99	De-activate Rejection of Undesired Annoying Calls (RUAC)	M	2 bytes
100 – 101	Invoke Advice of Charge (AOC)	M	2 bytes
102 – 103	Invoke Call Trace (COT)	M	2 bytes
2N – 2N+1	FCN	M	2 bytes

- 1
- 2 N, Number of Feature Codes" is coded in hexadecimal value, which indicates the number
- 3 of feature codes.
- 4 A feature code of up to four digits shall be encoded via BCD into the two bytes of the
- 5 feature code table entry as follows:
- 6
- represent these four digits as $D_1D_2D_3D_4$.
 - if the feature code (FC) of less than four digits is used, the digits shall be right
 - 7 justified and the unused digits shall be set to 'F'.
 - 8
 - 9

1
2
3

Coding:

First byte:

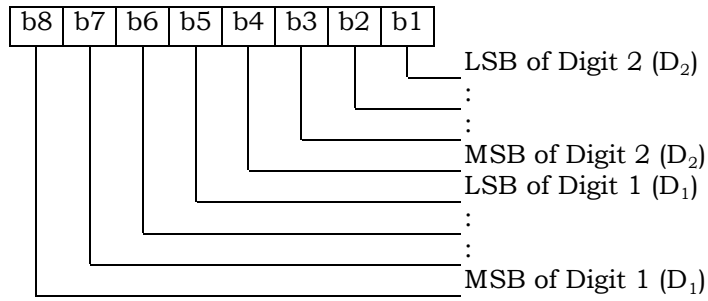

4
5

Second byte:

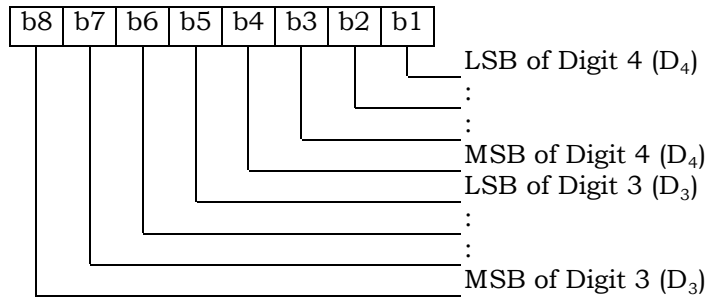

6

3.4.31 EF_{SPN} (CDMA Home Service Provider Name)

This EF contains the home service provider name and appropriate requirements for display by the ME.

Identifier: '6F41'		Structure: transparent		Optional	
File size: 35 bytes			Update activity: low		
Access Conditions:					
READ		ALW			
UPDATE		ADM			
INVALIDATE		ADM			
REHABILITATE		ADM			
Bytes	Description			M/O	Length
1	Display Condition			M	1 byte
2	Character Encoding			M	1 byte
3	Language Indicator			M	1 byte
4 – 35	Service Provider Name			M	32 bytes

- Display Condition

Contents: An indication of whether or not a service provider name should be displayed when the MS is registered in the home service area.

Coding:

Byte 1:

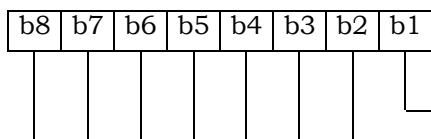

b1=0: display of registered system is not required
 b1=1: display of registered system is required
 RFU

Byte 2:

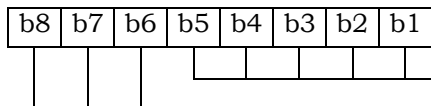

Character encoding as specified in informative [1]
 RFU

Byte 3:

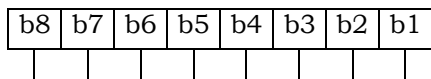

Language Indicator as specified in informative [1]

Byte 4 – 35:

- Service Provider Name

Contents: service provider string to be displayed

Coding: the string shall use SMS conventions as defined in Tables 9-1 and 9-2 of informative [1]. The string shall be left justified. Unused bytes shall be set to 'FF'.

3.4.32 EF_{USGIND} (Removable UIM_ID/SF_EUIMID Usage Indicator)

This EF indicates whether the 32 bits of the UIM_ID or ESN_ME is used as the “ESN” value for CAVE authentication and MS identification, as per Section 4.6.1. This EF also indicates whether the 56-bit of the SF_EUIMID or MEID shall be used as the “MEID” field over the air when Service n8 is allocated. This indicator shall be set to comply with US Code of Federal Regulations 47 (CFR) 1998 Part 22.919, where applicable.

Identifier: ‘6F42’		Structure: transparent		Mandatory
File size: 1 byte		Update activity: low		
Access Conditions:				
READ		CHV1		
UPDATE		ADM		
INVALIDATE		ADM		
REHABILITATE		ADM		
Bytes	Description	M/O	Length	
1	UIM ID/SF_EUIMID Usage Indicator	M	1 byte	

Coding:

- 1 bit is used as the UIM ID usage indicator.
- first bit = 0: ESN_ME is used for CAVE authentication and MS identification.
- first bit = 1: UIM_ID is used for CAVE authentication and MS identification.
- 1 bit is used as the SF_EUIMID usage indicator.
- second bit = 0: MEID is used for MS identification.
- second bit = 1: SF_EUIMID is used for MS identification.

Byte 1:

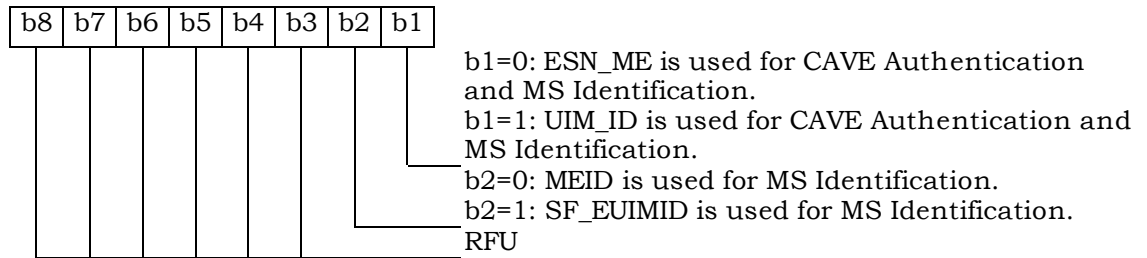

The default value for b1 shall be set to ‘0’.
 If service n8 is not allocated, the b2 bit shall be set to ‘0’ and shall not be interpreted by the ME.
 If service n8 is allocated and activated and the ME is assigned with ESN, then the b2 shall not be interpreted

3.4.33 EF_{AD} (Administrative Data)

This EF contains information concerning the mode of operation according to the type of UIM. It also provides an indication whether some ME features should be activated during the normal operation.

Identifier: '6F43'		Structure: transparent		Mandatory	
File size: 3+X bytes			Update activity: low		
Access Conditions:					
READ		ALW			
UPDATE		ADM			
INVALIDATE		ADM			
REHABILITATE		ADM			
Bytes	Description			M/O	Length
1	MS operation mode			M	1 byte
2 - 3	Additional information			M	2 bytes
4 - 3+X	RFU			O	X bytes

- MS operation mode
 Contents: mode of operation for the MS.
 Coding:
 Initial value
 - normal operation '00'
 Refer to [17] for other operational values.

Byte 1:

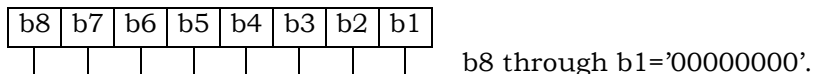

- Additional information
 Coding:
 - specific facilities (if b1=1 in byte 1);

Byte 2: (first byte of additional information)

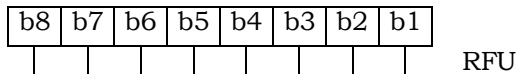

Byte 3:

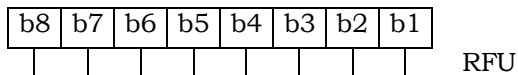

1 3.4.34 EF_{MDN} (Mobile Directory Number)

2 This EF stores the Mobile Directory Number, Type of Number, Numbering Plan,
 3 Presentation Indicator and Screening Indicator.
 4

Identifier: '6F44'		Structure: linear fixed		Optional	
Record length: 11 bytes			Update activity: low		
Access Conditions:					
READ		CHV1			
UPDATE		CHV1			
INVALIDATE		ADM			
REHABILITATE		ADM			
Bytes	Description		M/O	Length	
1	RFU	Number of digits	M	1 byte	
2 - 9	MDN		M	8 bytes	
10	NUMBER_TYPE and NUMBER_PLAN		M	1 byte	
11	PI and SI		M	1 byte	

5 Coding:
 6

7 Byte 1:

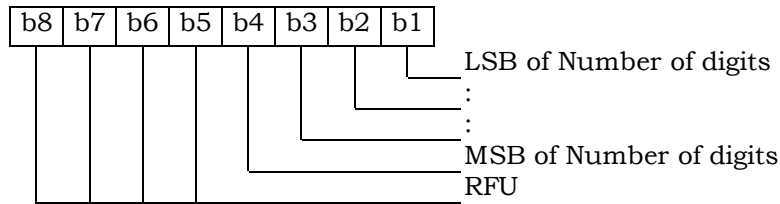

8
 9 Byte 2 through 9 store MDN up to 15 digits described in Section 6.3.1.4 of [14]. Each digit
 10 shall be encoded according to Table 6.7.1.3.2.4-4 of [14]. If MDN requires less than 15
 11 digits, excess nibbles at the end of data shall be set to 'F'.
 12

13 Byte 2:

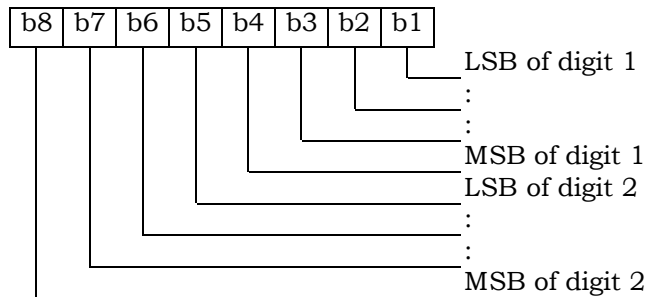

14

1 Byte 3:

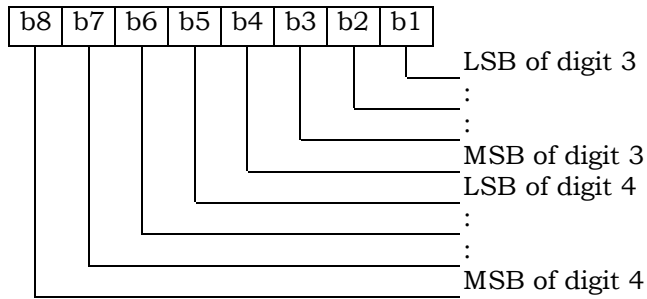

2 And Byte 4 through 9 shall follow the same format as Bytes 2 and 3.

3
4 Byte 10:

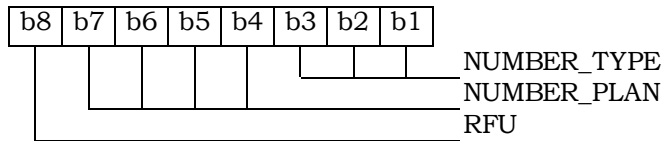

5 Refer to [14], Section 6.7.4.4.

6
7 Byte 11:

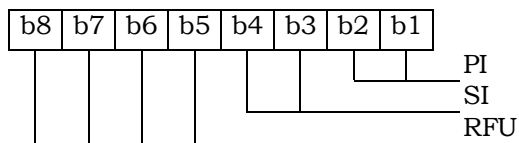

8 Refer to [14], Section 6.7.4.4.

9

1 3.4.35 EF_{MAXPRL} (Maximum PRL)

2 This EF stores the maximum size, in octets, that the R-UIM can support for EF Preferred
 3 Roaming List and EF Extended Preferred Roaming List. See 3.5.3.1 and 3.5.3.3 of [7] for
 4 more detail.

5

Identifier: '6F45'		Structure: transparent		Mandatory	
File size: 2 or 4 bytes			Update activity: Never		
Access Conditions:					
READ		CHV1			
UPDATE		ADM			
INVALIDATE		ADM			
REHABILITATE		ADM			
Bytes	Description			M/O	Length
1 - 2	MAX_PR_LIST_SIZE for EF _{PRL}			M	2 bytes
3 - 4	MAX_PR_LIST_SIZE for EF _{EPRL}			O	2 bytes

6

1 3.4.36 EF_{SPCS} (SPC Status)

2 This EF identifies whether the EF_{SPC} (Service programming code) is set to default and
 3 internally updated in the card to reflect the current state of SPC after an OTASP commit if
 4 the SPC was changed. Details of SPC are in [7], section 3.3.6.

Identifier: '6F46'		Structure: transparent		Mandatory	
File size: 1 byte			Update activity: low		
Access Conditions:					
READ		CHV1			
UPDATE		NEVER			
INVALIDATE		NEVER			
REHABILITATE		NEVER			
Bytes	Description			M/O	Length
1	SPC Status			M	1 byte

6
 7 - SPC Status

8
 9 Coding:
 10 Byte 1:

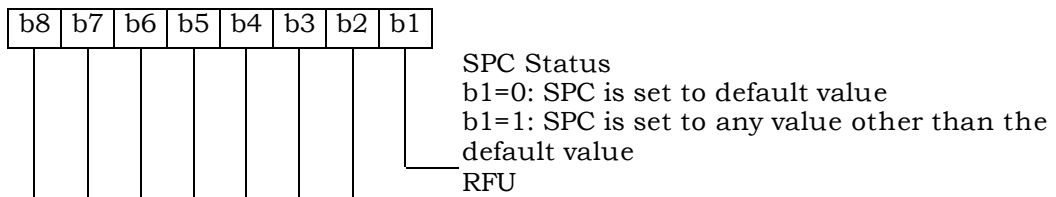

11
 12

1 3.4.37 EF_{ECC} (Emergency Call Codes)

2 This EF contains up to 5 emergency call codes.

Identifier: '6F47'		Structure: transparent		Optional
File size: 3n (n ≤ 5) bytes			Update activity: low	
Access Conditions:				
READ		ALW		
UPDATE		ADM		
INVALIDATE		ADM		
REHABILITATE		ADM		
Bytes	Description	M/O	Length	
1 - 3	Emergency Call Code 1	O	3 bytes	
4 - 6	Emergency Call Code 2	O	3 bytes	
(3n-2) to 3n	Emergency Call Code n	O	3 bytes	

3
4 - Emergency Call Code

5 Contents:

6 Emergency Call Code. Each digit is encoded in BCD format.

7 Coding:

8 The emergency call code is of a variable length with a maximum length of 6
9 digits. Each emergency call code is coded on three bytes, with each digit within
10 the code being coded on four bits as shown below. If a code of less than 6 digits
11 is chosen, then the unused nibbles shall be set to 'F'.

12 Byte 1:

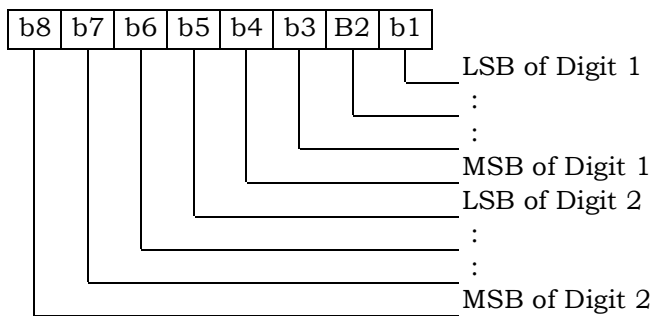

13

1

Byte 2:

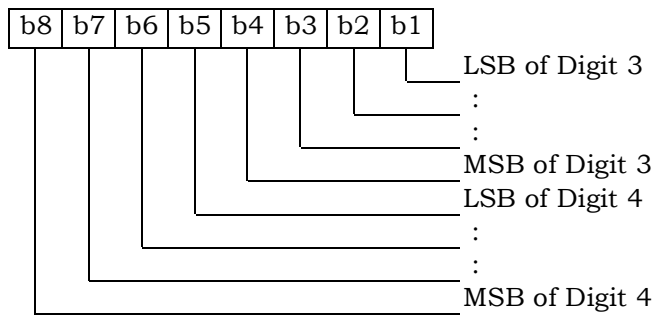

2

3

Byte 3:

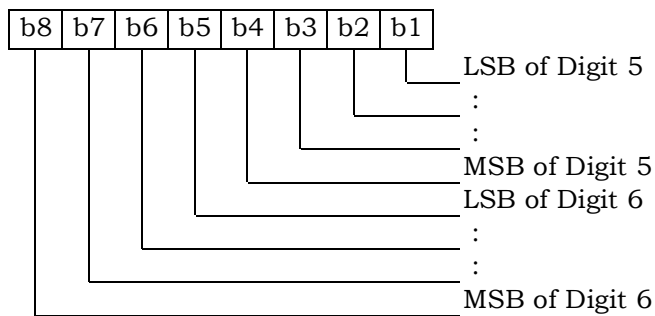

4

5

6

7

After R-UIM activation, the ME selects the Dedicated File DF_{CDMA} and optionally attempts to select EF_{ECC} . If EF_{ECC} is available, the ME requests the emergency call codes.

3.4.39 EF_{3GPDOPM} (3GPD Operation Mode)

If either service n20 or n38 is allocated (See Section 3.4.18), this EF shall be present. This EF stores the 3GPD Operation Mode Parameter Block defined in [7].

Identifier: '6F49'		Structure: transparent		Optional	
File size: 1 byte			Update activity: low		
Access Conditions:					
READ		CHV1			
UPDATE		CHV1			
INVALIDATE		ADM			
REHABILITATE		ADM			
Bytes	Description			M/O	Length
1	See [7], 3GPD Operational Mode Parameter Block			M	1 byte

Coding:

Byte 1:



1 3.4.40 EF_{SIPCAP} (SimpleIP Capability Parameters)

2 If service n20 is allocated (See Section 3.4.18), this EF shall be present. This EF stores the
 3 SimpleIP Capability Parameter Block defined in [7].

4

Identifier: '6F4A'		Structure: transparent		Optional	
File size: 4 bytes			Update activity: low		
Access Conditions:					
READ		CHV1			
UPDATE		ADM			
INVALIDATE		ADM			
REHABILITATE		ADM			
Bytes	Description			M/O	Length
1 - 4	See [7], SimpleIP Capability Parameter Block			M	4 bytes

5

1 3.4.41 EF_{MIPCAP} (MobileIP Capability Parameters)

2 If service n38 is allocated (See Section 3.4.18), this EF shall be present. This EF stores the
 3 MobileIP Capability Parameter Block defined in [7].

4

Identifier: '6F4B'		Structure: transparent		Optional	
File size: 5 bytes			Update activity: low		
Access Conditions:					
READ		CHV1			
UPDATE		ADM			
INVALIDATE		ADM			
REHABILITATE		ADM			
Bytes	Description		M/O	Length	
1-5	See [7], MobileIP Capability Parameter Block		M	5 bytes	

5

1 3.4.42 EF_{SIPUPP} (SimpleIP User Profile Parameters)

2 If service n20 is allocated (See Section 3.4.18), this EF shall be present. This EF stores the
 3 SimpleIP User Profile Parameter Block defined in [7].

4

Identifier: '6F4C'		Structure: transparent		Optional	
File size: 1+X			Update activity: low		
Access Conditions:					
READ		CHV1			
UPDATE		ADM			
INVALIDATE		ADM			
REHABILITATE		ADM			
Bytes	Description			M/O	Length
1	Length of SimpleIP User Profile Parameter Block			M	1 bytes
2 - X+1	See [7], SimpleIP User Profile Parameter Block			M	X bytes

5

1 3.4.43 EF_{MIPUPP} (MobileIP User Profile Parameters)

2 If service n38 is allocated (See Section 3.4.18), this EF shall be present. This EF stores the
 3 MobileIP User Profile Parameter Block defined in [7].

4

Identifier: '6F4D'		Structure: transparent		Optional	
File size: 1+X			Update activity: low		
Access Conditions:					
READ		CHV1			
UPDATE		ADM			
INVALIDATE		ADM			
REHABILITATE		ADM			
Bytes	Description			M/O	Length
1	Length of MobileIP User Profile Parameter Block			M	1 bytes
2 - X+1	See [7], MobileIP User Profile Parameter Block			M	X bytes

5

1 3.4.44 EF_{SIPSP} (SimpleIP Status Parameters)

2 If service n20 is allocated (See Section 3.4.18), this EF shall be present. This EF stores the
 3 SimpleIP Status Parameters Block defined in [7].

4

Identifier: '6F4E'		Structure: transparent		Optional	
File size: 1			Update activity: low		
Access Conditions:					
READ		CHV1			
UPDATE		CHV1			
INVALIDATE		ADM			
REHABILITATE		ADM			
Bytes	Description			M/O	Length
1	See [7], SimpleIP Status Parameters Block			M	1 byte

5

1 3.4.45 EF_{MIPSP} (MobileIP Status Parameters)

2 If service n38 is allocated (See Section 3.4.18), this EF shall be present. This EF stores the
 3 MobileIP Status Parameters Block defined in [7].

4

Identifier: '6F4F'		Structure: transparent		Optional	
File size: X			Update activity: low		
Access Conditions:					
READ		CHV1			
UPDATE		CHV1			
INVALIDATE		ADM			
REHABILITATE		ADM			
Bytes	Description			M/O	Length
1 - X	See [7], MobileIP Status Parameters Block			M	X bytes

5

1 3.4.46 EF_{SIPAPSS} (SimpleIP PAP SS Parameters)

2 If service n20 is allocated (See Section 3.4.18), this EF shall be present. This EF stores the
 3 SimpleIP PAP SS Parameter Block defined in [7].

4

Identifier: '6F50'		Structure: transparent		Optional	
File size: 1+X			Update activity: low		
Access Conditions:					
READ		CHV1			
UPDATE		CHV1			
INVALIDATE		ADM			
REHABILITATE		ADM			
Bytes	Description			M/O	Length
1	Length of SimpleIP PAP SS Parameter Block			M	1 bytes
2 - X+1	See [7], SimpleIP PAP SS Parameter Block			M	X bytes

5

1 3.4.47 Reserved

2

1 3.4.48 Reserved

2

1 3.4.49 EF_{PUZL} (Preferred User Zone List)

2 This EF stores the Preferred User Zone List, as described in Section 3.5.7 of [7].

3

Identifier: '6F53'		Structure: transparent		Optional	
File size: 'CUR_UZ_LIST_SIZE'			Update activity: low		
Access Conditions:					
READ		CHV1			
UPDATE		ADM			
INVALIDATE		ADM			
REHABILITATE		ADM			
Bytes		Description		M/O	Length
1- CUR_UZ_LIST_SIZE		PUZL (see Section 3.5.6 of [7])		M	CUR_UZ_LIST_SI ZE

4

1 3.4.50 EF_{MAXPUZL} (Maximum PUZL)

2 This EF stores the maximum size, in octets, that the R-UIM can support for EF Preferred
 3 User Zone List (See 3.5.7 of [7] for more detail) and the maximum number of User Zone
 4 entries that the R-UIM can support for EF_{PUZL} (See 3.5.6.1. of [7] for more detail).

5

Identifier: '6F54'		Structure: transparent		Optional	
File size: 5 bytes			Update activity: Never		
Access Conditions:					
READ		CHV1			
UPDATE		ADM			
INVALIDATE		ADM			
REHABILITATE		ADM			
Bytes	Description			M/O	Length
1 -3	MAX_UZ_LIST_SIZE			M	3 bytes
4 - 5	MAX_UZ			M	2 bytes

6

7

3.4.51 EF_{MECRP} (ME-specific Configuration Request Parameters)

This EF stores ME-specific parameters to be used to form the response to the Configuration Request command while secure mode is active. The ME shall update these ME-specific parameters during initializations.

Identifier: '6F55'		Structure: transparent		Mandatory	
File size: 3 bytes			Update activity: low		
Access Conditions:					
READ		CHV1			
UPDATE		CHV1			
INVALIDATE		ADM			
REHABILITATE		ADM			
Bytes	Description			M/O	Length
1	SCM			M	1 byte
2	MOB_P_REV			M	1 byte
3	Local Control			M	1 byte

Coding:

Byte 1:

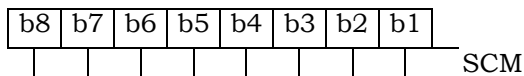

Note: b6 indicates if the ME is operating in slotted mode.

Byte 2:

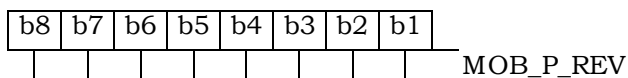

Byte 3:

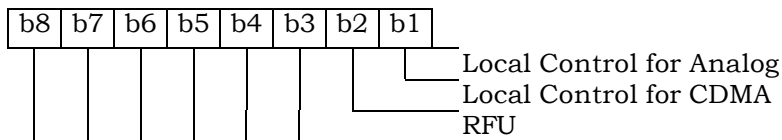

- 1 3.4.52 EF_{HRPDCAP} (HRPD Access Authentication Capability Parameters)
 2 If service n5 is allocated (See Section 3.4.18), this EF shall be present. This EF stores the
 3 HRPD Access Authentication Capability Parameters Block defined in Section 3.5.8.12 of [7].
 4
 5

Identifier: '6F56'		Structure: transparent		Optional	
File size: 3 bytes			Update activity: low		
Access Conditions:					
READ		CHV1			
UPDATE		ADM			
INVALIDATE		ADM			
REHABILITATE		ADM			
Bytes	Description			M/O	Length
1 - 3	See [7], HRPD Access Authentication Capability Parameters Block			M	3 bytes

6

7

3.4.53 EF_{HRPDUPP} (HRPD Access Authentication User Profile Parameters)

If service n5 is allocated (See Section 3.4.18), this EF shall be present. This EF stores the HRPD Access Authentication User Profile Parameters Block defined in Section 3.5.8.13 of [7].

Identifier: '6F57'		Structure: transparent		Optional	
File size: 1+X bytes			Update activity: low		
Access Conditions:					
READ		CHV1			
UPDATE		ADM			
INVALIDATE		ADM			
REHABILITATE		ADM			
Bytes	Description		M/O	Length	
1	Length of HRPD Access Authentication User Profile Parameters Block		M	1 byte	
2 - X+1	See [7], HRPD Access Authentication User Profile Parameters Block		M	X bytes	

1 3.4.54 EF_{CSSPR} (CUR_SSPR_P_REV)

2 This EF stores the protocol revision of the current preferred roaming list stored in the
 3 EF_{EPRL}. This information is used by the ME to parse the EF_{EPRL}.

4
 5

Identifier: '6F58'		Structure: transparent		Optional	
File size: 1			Update activity: low		
Access Conditions:					
READ		CHV1			
UPDATE		ADM			
INVALIDATE		ADM			
REHABILITATE		ADM			
Bytes	Description			M/O	Length
1	CUR_SSPR_P_REV			M	1 byte

6

3.4.55 EF_{arc} (Access Terminal Class)

If service n5 is allocated (See Section 3.4.18), this EF shall be present. This EF stores the class of access terminal used for Persistence Test in the system defined in [28].

Identifier: '6F59'		Structure: transparent		Optional	
File size: 1			Update activity: low		
Access Conditions:					
READ		CHV1			
UPDATE		ADM			
INVALIDATE		ADM			
REHABILITATE		ADM			
Bytes	Description			M/O	Length
1	Access Terminal Class			M	1 byte

Coding:

Byte 1:

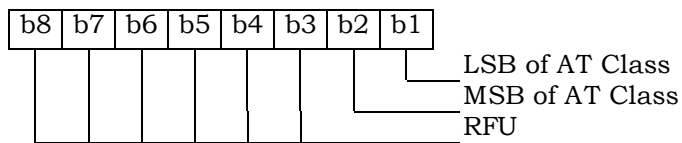

1 3.4.56 EF_{EPRL} (Extended Preferred Roaming List)

2 This EF stores the Extended Preferred Roaming List, as described in Section 3.5.3 of [7].

3 The Preferred Roaming List includes selection parameters from [5] and [14], Annex F.

4

Identifier: '6F5A'		Structure: transparent		Optional	
File size: 'MAX_PR_LIST_SIZE'			Update activity: low		
Access Conditions:					
READ		CHV1			
UPDATE		ADM			
INVALIDATE		ADM			
REHABILITATE		ADM			
Bytes	Description	M/O	Length		
1- PR_LIST_ SIZE	PR_LIST (see Section 3.5.5 of [7])	M	PR_LIST_SIZE		

5

6

3.4.57 EF_{BCSMscfg} (Broadcast Short Message Configuration)

If service n14 is allocated, this EF shall be present.

This EF contains the operator broadcast configuration setting for Broadcast SMS. This information, determined by the operator, defines the filtering criteria that can be used by the Mobile Equipment (ME) to receive Broadcast SMS.

Identifier: '6F5B'		Structure: transparent		Optional	
File size: 1 byte			Update activity: low		
Access Conditions:					
READ		CHV1			
UPDATE		ADM			
INVALIDATE		ADM			
REHABILITATE		ADM			
Bytes	Description			M/O	Length
1	Operator Broadcast Configuration			M	1 byte

Coding:

Byte 1:

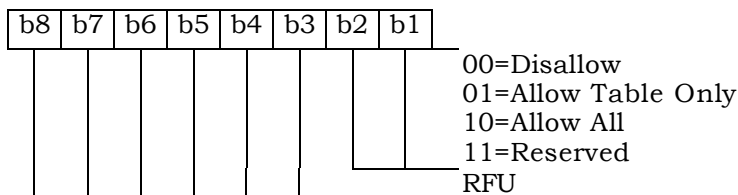

Operator configuration includes filtering criteria imposed by a service provider.

Field Name	Description
Disallow	This setting disables the mobile station's broadcast SMS capability (i.e., the mobile station will not process broadcast SMS).
Allow Table Only	This setting allows the mobile station to receive only broadcast messages for the service categories that have been programmed in EF _{BCSMstable} .
Allow All	This setting allows the mobile station to receive broadcast messages for all service categories.

3.4.58 EF_{BCSMSpref} (Broadcast Short Message Preference)

If service n14 is allocated, this EF shall be present.

This EF contains the user broadcast configuration setting for Broadcast SMS. This information, determined by the user, defines the filtering criteria that can be used by the Mobile Equipment (ME) to receive Broadcast SMS.

Identifier: '6F5C'		Structure: transparent		Optional	
File size: 1 byte			Update activity: high		
Access Conditions:					
READ		CHV1			
UPDATE		CHV1			
INVALIDATE		ADM			
REHABILITATE		ADM			
Bytes	Description			M/O	Length
1	User Broadcast Configuration			M	1 byte

Coding:

Byte 1:

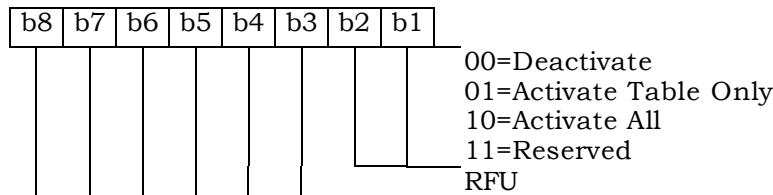

User configuration includes filtering criteria determined by the mobile user.

Field Name	Description
Deactivate	This setting deactivates the mobile station's broadcast SMS functions (i.e., the mobile station will not process broadcast SMS).
Activate Table Only	This setting allows the mobile station to receive only broadcast messages for the service categories that have been programmed in EF _{BCSMStable} , subject to any additional filtering criteria included in EF _{BCSMStable} based on user preferences. This setting is only valid if the operator configuration is not Disallow. Moreover, the mobile user can selectively

	enable and disable individual programmed entries in $EF_{BCSMStable}$.
Activate All	Activate All This setting allows the mobile station to receive broadcast messages for all service categories. This setting is only valid if the operator configuration is "Allow All". $EF_{BCSMStable}$ will not be consulted for this setting.

1

2

1 3.4.59 EF_{BCSMStable} (Broadcast Short Message Table)

2 If service n14 is allocated, this EF shall be present.

3 This EF contains information in accordance with [8] comprising service category program
 4 parameters, which can be used by the Mobile Equipment (ME) for Broadcast SMS filtering. See
 5 Section 4.5.19 of [8] for more detail.

6 Each record in this EF is linked to a record with the same record index in EF_{BCSMSF}.

7

Identifier: '6F5D'		Structure: linear fixed		Optional
Record Length: 7+X byte			Update activity: high	
Access Conditions:				
READ		CHV1		
UPDATE		ADM		
INVALIDATE		ADM		
REHABILITATE		ADM		
Bytes	Description	M/O	Length	
1	Status	M	1 byte	
2 - 3	Service Category	M	2 bytes	
4	Language	M	1 byte	
5	Max Messages	M	1 byte	
6	Alert Option	M	1 byte	
7	Label Encoding	M	1 byte	
8 to 7+X	Label	M	X byte	

8 - Status

9 Contents:

10 Status byte of the record which can be used as a pattern in the SEEK command.

11

12 Coding:

13 Byte 1:

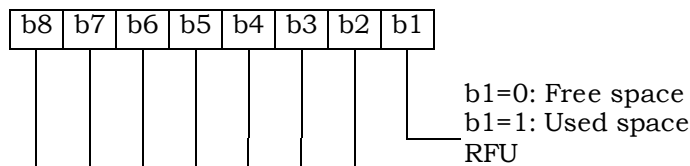

14

1
2
3
4
5
6
7
8
9
10
11
12
13

Byte 2:

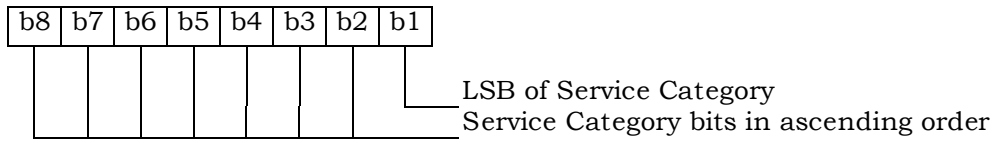

Byte 3:

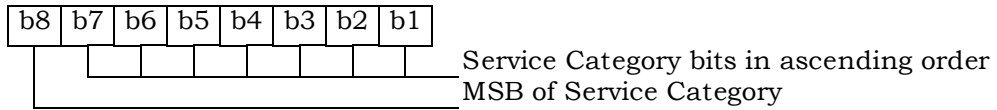

Byte 4:

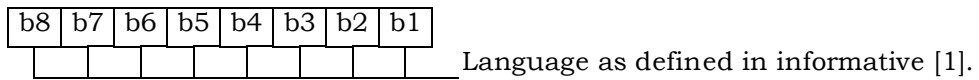

Byte 5:

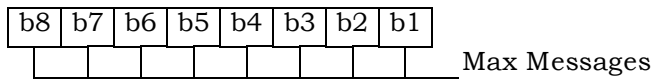

Byte 6:

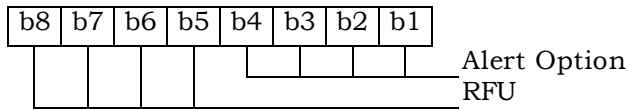

Byte 7:



1 3.4.60 EF_{BCSMSP} (Broadcast Short Message Parameter)

2 If service n14 is allocated, this EF shall be present.

3 This EF contains selection flag and priority associated with service categories and used by the
 4 ME for filtering of BC-SMS. Each record in this EF is linked to a record with the same record
 5 index in EF_{BCSMStable}.

6

Identifier: '6F5E'		Structure: linear fixed		Optional	
Record Length: 2 bytes			Update activity: high		
Access Conditions:					
READ		CHV1			
UPDATE		CHV1			
INVALIDATE		ADM			
REHABILITATE		ADM			
Bytes	Description		M/O	Length	
1	Select		M	1 byte	
2	Priority		M	1 byte	

7 Coding:

8 Byte 1:

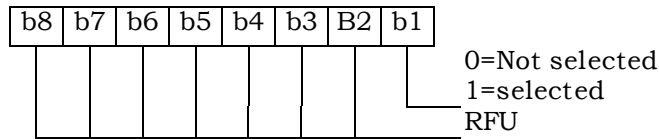

9

10 Byte 2:

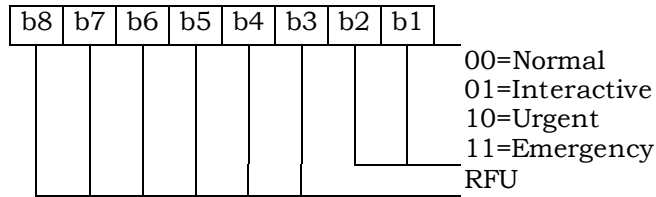

11

12 Unused records are filled with 'FF'. When the b1 of Byte 1 is set to '1', then the ME shall
 13 filter the BC-SMS according to the priority indicated in Byte 2.

14

1 3.4.61 EF_{IMPI} (IMS private user identity)

2 If service n°7 is allocated, this EF shall be present.

3 This EF contains the private user identity of the user.

4

Identifier: '6F5F'		Structure: transparent		Optional	
File size: X bytes			Update activity: low		
Access Conditions:					
READ		CHV1			
UPDATE		ADM			
DEACTIVATE		ADM			
ACTIVATE		ADM			
Bytes	Description			M/ O	Length
1 to X	NAI TLV data object			M	X bytes

5
6 - NAI

7 Contents:

8 - Private user identity of the user.

9 Coding:

10 - For contents and syntax of NAI TLV data object values see IETF RFC 2486 [34]. The
11 NAI shall be encoded to an octet string according to UTF-8 encoding rules as
12 specified in IETF RFC 3629 [46]. The tag value of the NAI TLV data objects shall be
13 '80'.
14

1 3.4.62 EF_{DOMAIN} (Home Network Domain Name)

2 If service n°7 is allocated, this EF shall be present.

3 This EF contains the home operator's network domain name SIP URI.

Identifier: '6F60'		Structure: transparent		Optional
File size: X bytes			Update activity: low	
Access Conditions:				
READ		CHV1		
UPDATE		ADM		
DEACTIVATE		ADM		
ACTIVATE		ADM		
Bytes	Description		M/ O	Length
1 to X	URI TLV data object		M	X bytes

4

5 - URI

6 Contents:

7 -Home Network Domain Name SIP URI.

8 Coding:

9 -For contents and syntax of URI TLV data object values see IETF RFC 3261[33]. The
10 URI shall be encoded to an octet string according to UTF-8 encoding rules as
11 specified in IETF RFC 3629 [46]. The tag value of the URI TLV data objects shall be
12 '80'.

13

1 3.4.63 EF_{IMPU} (IMS public user identity)

2 If service n°7 is allocated, this EF shall be present.

3 This EF contains values for public SIP Identities (SIP URI) of the user.

4 The EF consists of one or more records, with each record able to hold a set of public user
5 identities.

6

Identifier: '6F61'		Structure: linear fixed		Optional
Record length: X bytes			Update activity: low	
Access Conditions:				
READ		CHV1		
UPDATE		ADM		
DEACTIVATE		ADM		
ACTIVATE		ADM		
Bytes	Description	M/ O	Length	
1 to X	URI TLV data object	M	X bytes	

7
8 - URI

9 Contents:

10 - Public user identity by which other parties know the subscriber, in the format of
11 SIP URL, tel URL, or both.

12 Coding:

13 -For contents and syntax of URI TLV data object values see IETF RFC 3261[33]. The
14 URI shall be encoded to an octet string according to UTF-8 encoding rules as
15 specified in IETF RFC 3629 [46]. The tag value of the URI TLV data objects shall be
16 '80'.
17

1 3.4.64 EF_{PCSCF} (Proxy Call Session Control Function)

2 If service n°7 is allocated, this EF shall be present.

3 This EF contains one or more Proxy Call Session Control Function addresses. The first
 4 record in the EF shall be considered to be of the highest priority. The last record in the EF
 5 shall be considered to be the lowest priority.

6

Identifier: '6F62'		Structure: linear fixed		Optional	
Record length: X bytes			Update activity: low		
Access Conditions:					
READ		CHV1			
UPDATE		ADM			
DEACTIVATE		ADM			
ACTIVATE		ADM			
Bytes	Description			M/ O	Length
1 to X	P-CSCF TLV data object			M	X bytes

7

8 - P-CSCF

9 Contents:

10 - Address of Proxy Call Session Control Function, in the format of FQDN, an IPv4
 11 address, or an IPv6 address.

12 Coding:

13 - The tag value of this P-CSCF TLV data objects shall be '80'. The format of the data
 14 object is as follows:

Field	Length (bytes)
Tag	1
Length	2

Address Type	1
Address Length	1
P-CSCF Address	Address Length

15

16 Address Type: Type of the P-CSCF address.

17 This field shall be set to the type of the P-CSCF address according to
 18 the following:

19

Value	Name
00000000	FQDN
00000001	Ipv4
00000010	Ipv6
Reserved	Reserved

20

21 Address Length: Length of the P-CSCF address

22 This field shall be set to the length of the P-CSCF address, in units
 23 of byte.
 24

1
2
3
4
5
6

P-CSCF Address: Address of the Proxy Call Session Control Function
This field shall be set to the address of the Proxy Call Session
Control Function. When the P-SCSF type is set to 0x00, the
corresponding P-CSCF Address shall be encoded to an octet string
according to UTF-8 encoding rules as specified in IETF RFC 3629 [46].

1 3.4.65 EF_{BAKPARA} (Currently used BAK Parameters)

2 If service n°39 is allocated, this EF shall be present.

3 This EF contains the triple (BCMCS_Flow_ID, BAK_ID, BAK_Expire) corresponding to BAK
4 keys that have been delivered to the R-UIM and are currently used. See [36] for more
5 details.

6

Identifier: '6F63'		Structure: Linear Fixed		Optional
Record length: X+Y+Z+3 bytes			Update activity: high	
Access Conditions:				
READ		CHV1		
UPDATE		ADM		
DEACTIVATE		ADM		
ACTIVATE		ADM		
Bytes	Description	M/O	Length	
1	Length of BCMCS_Flow_ID	M	1 byte	
2 to X + 1	BCMCS_Flow_ID	M	X bytes	
X+2	Length of BAK_ID	M	1 byte	
X+3 to X+Y+2	BAK_ID	M	Y bytes	
X+Y+3	Length of BAK_Expire	M	1 byte	
X+Y+4 to X+Y+Z+3	BAK_Expire	M	Z bytes	

7
8 - Length of BCMCS_Flow_ID

9 Content: number of bytes of the following data item containing the BCMCS flow
10 identifier.

11 Coding: Binary.

12 - BCMCS_Flow_ID

13 Content: BCMCS Flow Identifier

14 Coding: Binary.

15 - Length of BAK_ID

16 Content: number of bytes of the following data item containing the BAK identifier.

17 Coding: Binary

18 - BAK_ID

19 Content: BAK Identifier

20 Coding: Binary.

21 - Length of BAK_Expire

22 Content: number of bytes of the following data item containing the BAK_Expire.

23 Coding: Binary

24 - BAK_Expire

- 1 Content: BAK_Expire
- 2 Coding: Binary.
- 3

1 3.4.66 EF_{UpBAKPARA} (Updated BAK Parameters)

2 If service n°39 is allocated, this EF shall be present.

3 This EF contains the triple (BCMCS_Flow_ID, BAK_ID, BAK_Expire) corresponding to BAK
4 keys that have been delivered to the R-UIM but have not yet been used. See [36] for more
5 details.

6

Identifier: '6F64'		Structure: cyclic		Optional
Record length: X+Y+Z+3 bytes		Update activity: high		
Access Conditions:				
READ		CHV1		
UPDATE		ADM		
DEACTIVATE		ADM		
ACTIVATE		ADM		
Bytes	Description	M/O	Length	
1	Length of BCMCS_Flow_ID	M	1 byte	
2 to X + 1	BCMCS_Flow_ID	M	X bytes	
X+2	Length of BAK_ID	M	1 byte	
X+3 to X+2+Y	BAK_ID	M	Y bytes	
X+Y+3	Length of BAK_Expire	M	1 byte	
X+Y+4 to X+Y+Z+3	BAK_Expire	M	Z bytes	

7
8 - Length of BCMCS_Flow_ID

9 Content: number of bytes of the following data item containing the BCMCS flow
10 identifier.

11 Coding: Binary

12 - BCMCS_Flow_ID

13 Content: BCMCS Flow Identifier

14 Coding: Binary.

15 - Length of BAK_ID

16 Content: number of bytes of the following data item containing the BAK identifier.

17 Coding: Binary

18 - BAK_ID

19 Content: BAK Identifier

20 Coding: Binary.

21 - Length of BAK_Expire

22 Content: number of bytes of the following data item containing the BAK_Expire.

23 Coding: Binary

24 - BAK_Expire

- 1 Content: BAK_Expire
- 2 Coding: Binary.
- 3

1 3.4.67 EF_{MMSN} (MMS Notification)

2 If service n°40 is allocated, this file shall be present.

3 This EF contains information in accordance with [37] comprising MMS notifications (and
4 associated parameters) which have been received by the ME from the network.

Identifier: '6F65'		Structure: Linear fixed		Optional	
Record length: 4+X bytes			Update activity: low		
Access Conditions:					
READ		CHV1			
UPDATE		CHV1			
INVALIDATE		ADM			
REHABILITATE		ADM			
Bytes	Description	M/O	Length		
1 - 2	MMS Status	M	2 bytes		
3	MMS Implementation	M	1 byte		
4 to X+3	MMS Notification	M	X bytes		
X+4	Extension file record number	M	1 byte		

5
6 - MMS Status

7 Content:

8 -The status bytes contain the status information of the notification.

9 Coding:

10 -b1 indicates whether there is valid data or if the location is free. b2 indicates
11 whether the MMS notification has been read or not. Bits b3-b4 of the first byte
12 indicate the MM retrieval, MM rejection, or MM forwarding status, Bits b5-b8 of the
13 first byte and the entire second byte are reserved for future use.

14 First byte:

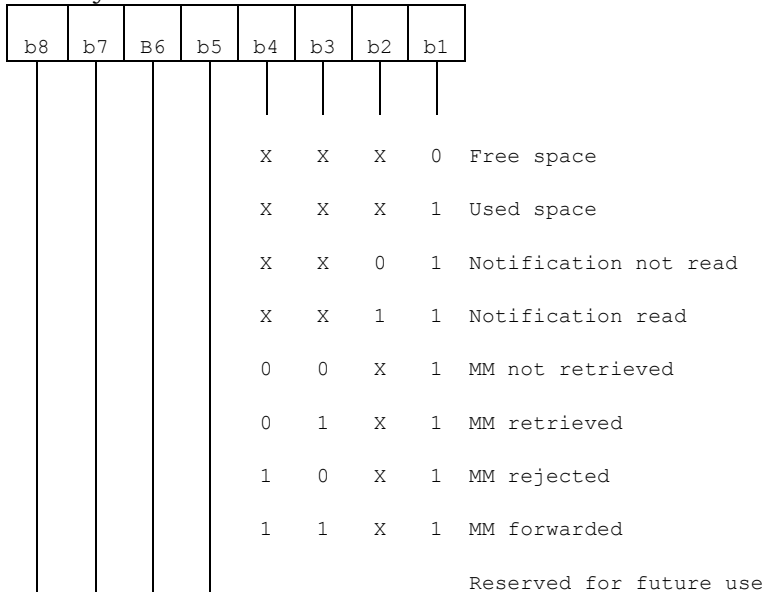

15

16 Second byte:

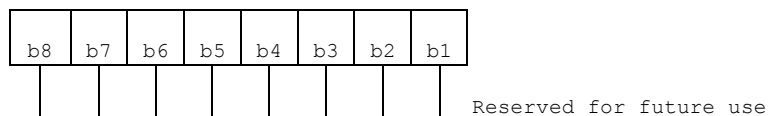

- 1
- 2 - MMS Implementation
- 3 Contents:
- 4 -The MMS Implementation indicates the used implementation type, e.g. WAP, M-
- 5 IMAP, SIP.
- 6 Coding:
- 7 -Allocation of bits:
- 8 • Bit number Parameter indicated
- 9 1 WAP implementation of MMS
- 10 2 M-IMAP implementation of MMS
- 11 3 SIP implementation of MMS
- 12 4-8 Reserved for future use
- 13 • Bit value Meaning
- 14 0 Implementation not supported.
- 15 1 Implementation supported.
- 16 - MMS Notification
- 17 Contents:
- 18 -The MMS Notification contains the MMS notification.
- 19 Coding:
- 20 -The MMS Notification is coded according to the MMS Implementation as indicated
- 21 in Byte 3.
- 22 -Any unused byte shall be set to 'FF'.
- 23 - Extension file record number
- 24 Contents:
- 25 -extension file record number. This byte identifies the number of a record in the
- 26 EF_{EXT8} containing extension data for the notification information. The use of this
- 27 byte is optional. If it is not used it shall be set to 'FF'.
- 28 Coding:
- 29 -binary.

1 3.4.68 EF_{EXT8} (Extension 8)

2 If service n°41 is allocated, this file shall be present.

3 This EF contains extension data of a MMS Notification (Multimedia Messaging Service).

4

Identifier: '6F66'		Structure: linear fixed		Optional
Record length: X+2 bytes			Update activity: low	
Access Conditions:				
READ		CHV1		
UPDATE		CHV1		
INVALIDATE		ADM		
REHABILITATE		ADM		
Bytes	Description	M/O	Length	
1	Record type	M	1 byte	
2 to X+1	Extension data	M	X bytes	
X+2	Identifier	M	1 byte	

5

6 For contents and coding see [30].

7

1 3.4.69 EF_{MMSICP} (MMS Issuer Connectivity Parameters)

2 If service n°40 is allocated, this file shall be present.

3 This EF contains values for Multimedia Messaging Connectivity Parameters as determined
 4 by the issuer, which can be used by the ME for MMS network connection. This file may
 5 contain one or more sets of Multimedia Messaging Issuer Connectivity Parameters. The
 6 first set of Multimedia Messaging Issuer Connectivity Parameters is used as the default set.
 7 Each set of Multimedia Messaging Issuer Connectivity Parameters may consist of one or
 8 more Interface to Core Network and Bearer information TLV objects (only for WAP), but
 9 shall contain only one MMS implementation TLV object (for WAP, M-IMAP and SIP), one
 10 MMS Relay/Server TLV object (for WAP, M-IMAP and SIP) and one Gateway TLV object
 11 (only for WAP). The order of the Interface to Core Network and Bearer information TLV
 12 objects in the MMS Connectivity TLV object defines the priority of the Interface to Core
 13 Network and Bearer information, with the first TLV object having the highest priority.

Identifier: '6F67'		Structure: Transparent		Optional	
File Size: X ₁ +...+ X _n bytes			Update activity: low		
Access Conditions:					
READ		CHV1			
UPDATE		ADM			
INVALIDATE		ADM			
REHABILITATE		ADM			
Bytes		Description		M/O	Length
1 to X ₁		MMS Connectivity Parameters TLV object		M	X ₁ bytes
X ₁ +1 to X ₁ + X ₂		MMS Connectivity Parameters TLV object		O	X ₂ bytes
...		...			
X ₁ +...+ X _{n-1} +1 to X ₁ +...+ X _n		MMS Connectivity Parameters TLV object		O	X _n bytes

- 14
 15 - MMS Connectivity Parameters tags

Description	Tag Value
MMS Connectivity Parameters Tag	'AB'
MMS Implementation Tag	'80'
MMS Relay/Server Tag	'81'
Interface to Core Network and Bearer Information Tag	'82'
Gateway Tag	'83'
MMS Authentication Mechanism Tag	'84'
MMS Authentication ID Tag	'85'

- 16
 17 - MMS Connectivity Parameters contents

Description	Value	M/O	Length (bytes)
MMS Connectivity Parameters Tag	'AB'	M	1
Length	Note 1	M	Note 2
MMS Implementation Tag	'80'	M	1
Length	1	M	1
MMS Implementation Information	--	M	1
MMS Relay/Server Tag	'81'	M	1
Length	X	M	Note 2
MMS Relay/Server Address	--	M	X
1 st Interface to Core Network and Bearer Information Tag (highest priority)	'82'	C2	1
Length	Y1	C2	Note 2
1 st Interface to Core Network and Bearer information	--	C2	Y1
2 nd Interface to Core Network and Bearer Information Tag	'82'	C2	1
Length	Y2	C2	Note 2
2 nd Interface to Core Network and Bearer information	--	C2	Y2
...			
N th Interface to Core Network and Bearer Information Tag (lowest priority)	'82'	C2	1
Length	Y3	C2	Note 2
N th Interface to Core Network and Bearer information	--	C2	Y3
Gateway Tag	'83'	O	1
Length	Z	O	Note 2
Gateway Information	--	O	Z
MMS Authentication Mechanism Tag	'84'	C1	1
Length	X	C1	Note 2
MMS Authentication Mechanism	--	C1	X
MMS Authentication ID Tag	'85'	C1	1
Length	X	C1	Note 2
MMS Authentication ID (Login_ID)	--	C1	X
NOTE 1: This is the total size of the constructed TLV object.			
NOTE 2: The length is coded according to ISO/IEC 8825.			
C1: only present if M-IMAP or SIP indicated in tag 80			
C2: only present if WAP is indicated in tag 80			

1
2
3
4
5
6
7
8
9
10
11
12
13

- MMS Implementation Tag '80'

See [30] for contents and coding.

-MMS Relay/server Tag '81'

Contents:

-The MMS relay/server contains the address of the associated MMS relay/server; In addition, for M-IMAP and SIP, authentication mechanism and authentication ID (Login ID) are also included.

Coding:

-The MMS relay/server address is coded as URI appropriate to the MM1 implementation being used, for example SIP, or M-IMAP.

- Interface to Core Network and Bearer Information Tag '82'

Contents:

1 -The Interface to Core Network and Bearer Information may contain the following
2 information to set up the bearer: Bearer, Address, Type of address, Speed, Call type,
3 Authentication type, Authentication id, Authentication password.

4 Coding:

5 -The coding is according to the guideline provided in [37]. If MMS implementation
6 type is WAP, 1st Interface to Core Network and Bearer Information is mandatory. If
7 MMS implementation type is M-IMAP or SIP, no Interface to Core Network and
8 Bearer Information is needed.

- 9 - Gateway Tag '83'

10 Contents:

11 -The Gateway may contain the following information; Address, Type of address, Port,
12 Service, Authentication type, Authentication id and Authentication password.

13 Coding:

14 -The coding is according to the guideline provided in [37].

- 15 - MMS Authentication Mechanism Tag '84'

16 Contents:

17 - The MMS authentication mechanism contains the authentication mechanism for
18 MMS. It is mandatory for M-IMAP and SIP.

19 Coding:

20 - The MMS authentication mechanism is coded as table 4.10.1-1.

- 21 - MMS Authentication ID Tag '85'

22 Contents:

23 - The MMS authentication ID contains the authentication ID for MMS. It is
24 mandatory for M-IMAP and SIP.

25 Coding:

26 -The coding is according to the guideline provided in [37].

27 Unused bytes shall be set to 'FF'.
28

1 3.4.70 EF_{MMSUP} (MMS User Preferences)

2 If service n°40 is allocated, this file shall be present.

3 This EF contains values for Multimedia Messaging Service User Preferences, which can be
4 used by the ME for user assistance in preparation of mobile multimedia messages (e.g.
5 default values for parameters that are often used).

Identifier: '6F68'	Structure: Linear Fixed	Optional	
Record Length: X bytes	Update activity: low		
Access Conditions:			
READ	CHV1		
UPDATE	CHV1		
INVALIDATE	ADM		
REHABILITATE	ADM		
Bytes	Description	M/O	Length
1 to X	MMS User Preference TLV Objects	M	X bytes

- 6
7 - MMS User Preference tags

Description	Tag Value
MMS Implementation Tag	'80'
MMS User preference profile name Tag	'81'
MMS User Preference information Tag	'82'

- 8
9 - MMS User Preference information

Description	Value	M/O	Length (bytes)
MMS Implementation Tag	'80'	M	1
Length	1	M	Note
MMS Implementation information	--	M	1
MMS User preference profile name Tag	'81'	M	1
Length	X	M	Note
MMS User profile name	--	M	X
MMS User Preference information Tag	'82'	M	1
Length	Y	M	Note
MMS User Preference information	--	M	Y
NOTE: The length is coded according to ISO/IEC 8825.			

- 10
11 - MMS Implementation Tag '80'

12 For contents and coding see [30]

- 13 - MMS User preference profile name Tag '81'

14 Contents:

15 -Alpha tagging of the MMS user preference profile.

16 Coding:

17 -this alpha-tagging shall use either:

- 18 • the SMS default 7-bit coded alphabet as defined in [38] with bit 8 set to 0. The
19 alpha identifier shall be left justified; or

- 1 • one of the UCS2 coded options as defined in the annex of [30].
- 2 - MMS User Preference information Tag '82'
- 3 Contents:
- 4 -The following information elements may be coded; Sender Visibility, Delivery
- 5 Report, Read-Reply, Priority, Time of Expiry and Earliest Delivery Time. Refer to [37],
- 6 [39], [40], and [41].
- 7 Coding:
- 8 -Depending upon the MMS implementation as indicated in Tag '80'.
- 9

1 3.4.71 EF_{MMSUCP} (MMS User Connectivity Parameters)

2 If service n°40 and n°42 are allocated, this file shall be present.

3 This EF contains values for Multimedia Messaging Connectivity Parameters as determined
 4 by the user, which can be used by the ME for MMS network connection. This file may
 5 contain one or more sets of Multimedia Messaging User Connectivity Parameters. Each set
 6 of Multimedia Messaging User Connectivity Parameters may consist of one or more
 7 Interface to Core Network and Bearer information TLV objects (only for WAP), but shall
 8 contain only one MMS implementation TLV object (for WAP, M-IMAP and SIP), one MMS
 9 Relay/Server TLV object (for WAP, M-IMAP and SIP) and one Gateway TLV object (only for
 10 WAP). The order of the Interface to Core Network and Bearer information TLV objects in
 11 the MMS Connectivity TLV object defines the priority of the Interface to Core Network and
 12 Bearer information, with the first TLV object having the highest priority.

Identifier: '6F69'		Structure: Transparent		Optional	
File Size: X ₁ +...+ X _n bytes			Update activity: low		
Access Conditions:					
READ		CHV1			
UPDATE		CHV1/CHV2 (fixed during administrative management)			
INVALIDATE		ADM			
REHABILITATE		ADM			
Bytes		Description		M/O	Length
1 to X ₁		MMS Connectivity Parameters TLV object		O	X ₁ bytes
X ₁ +1 to X ₁ + X ₂		MMS Connectivity Parameters TLV object		O	X ₂ bytes
...		...			
X ₁ +...+ X _{n-1} +1 to X ₁ +...+ X _n		MMS Connectivity Parameters TLV object		O	X _n bytes

13 For the contents and coding see 3.4.69.

14

3.4.72 EF_{AuthCapability} (Authentication Capability)

If service n°43 is allocated, this file shall be present. This EF stores authentication capabilities for each application supported by the R-UIM.

Identifier: '6F6A'		Structure: Linear Fixed		Optional	
Record Length: 5 bytes			Update activity: low		
Access Conditions:					
READ		CHV1			
UPDATE		ADM			
INVALIDATE		ADM			
REHABILITATE		ADM			
Bytes	Description	M/O	Length		
1	Application ID	M	1 byte		
2-3	Authentication Capability	M	2 bytes		
4-5	Reserved	M	2 bytes		

Coding:

Byte 1:

The coding for Application ID is as follows:

Binary Value	Application ID
'00000000'	MMS
'00000001'	MMD
'00000010'-'11111111'	Reserved

Byte 2:

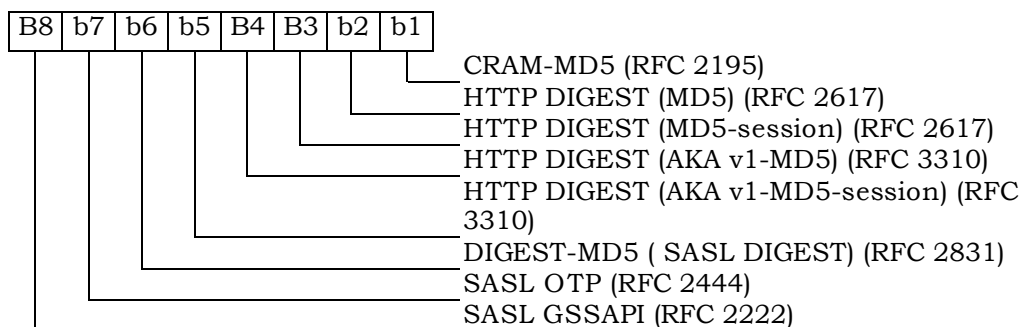

Bytes 3-5 are reserved.

The R-UIM shall set each subfield to '1' if it supports the corresponding authentication mechanism.

1 3.4.73 EF_{3GCIK} (3G Cipher and Integrity Keys)

2 If service n°30 is allocated, this file shall be present.

3 This EF contains the cipher key CK, the integrity key IK.

Identifier : '6F6B'		Structure : transparent		Optional
File size: 32 bytes		Update activity: low		
Access Conditions:				
READ		CHV1		
UPDATE		ADM		
INVALIDATE		ADM		
REHABILITATE		ADM		
Bytes	Description	M/O	Length	
1 - 16	Cipher key CK	M	16 bytes	
17 - 32	Integrity key IK	M	16 bytes	

4

5

6

- Cipher key CK.

7

Coding:

8

-The least significant bit of CK is the least significant bit of the 16th byte. The most significant bit of CK is the most significant bit of the 1st byte.

9

10

11

- Integrity key IK.

12

Coding:

13

The least significant bit of IK is the least significant bit of the 32nd byte. The most significant bit of IK is the most significant bit of the 17th byte.

14

15

3.4.74 EF_{DCK} (De-Personalization Control Keys)

If service no°46 is allocated, this EF shall be present.

This EF provides storage for the de-personalization control keys associated with the OTA de-personalization cycle of [44].

Identifier: '6F6C'		Structure: transparent		Optional
File size: 20 bytes		Update activity: low		
Access Conditions:				
READ		CHV1		
UPDATE		CHV1		
INVALIDATE		ADM		
REHABILITATE		ADM		
Bytes	Description	M/O	Length	
1 to 4	8 digits of Network Type 1 de-personalization control key	M	4 bytes	
5 to 8	8 digits of Network Type 2 de-personalization control key	M	4 bytes	
9 to 12	8 digits of service provider de-personalization control key	M	4 bytes	
13 to 16	8 digits of corporate de-personalization control key	M	4 bytes	
17 to 20	8 digits of HRPD Network de-personalization control key	M	4 bytes	

Empty control key fields shall be coded 'FFFFFFFF'.

1 3.4.75 EF_{GID1} (Group Identifier Level 1)

2 If service no°44 is allocated, this EF shall be present.

3 This EF contains identifiers for particular R-UIM/ME associations. It can be used to identify
4 a group of R-UIMs for a particular application.

5

Identifier: '6F6D'		Structure: transparent		Optional	
File size: 1 to n bytes			Update activity: low		
Access Conditions:					
READ		CHV1			
UPDATE		ADM			
INVALIDATE		ADM			
REHABILITATE		ADM			
Bytes	Description			M/ O	Length
1 to n	R-UIM group identifier(s)			O	n bytes

6

7

1 3.4.76 EF_{GID2} (Group Identifier Level 2)

2 If service no°45 is allocated, this EF shall be present.

3 This EF contains identifiers for particular R-UIM/ME associations. It can be used to identify
 4 a group of R-UIMs for a particular application.

5

Identifier: '6F6E'		Structure: transparent		Optional	
File size: 1 to n bytes			Update activity: low		
Access Conditions:					
READ		CHV1			
UPDATE		ADM			
INVALIDATE		ADM			
REHABILITATE		ADM			
Bytes	Description			M/ O	Length
1 to n	R-UIM group identifier(s)			O	n bytes

6

7

NOTE: The structure of EFGID1 and EFGID2 are identical. They are provided to allow
 8 the network operator to enforce different levels of security dependant on an
 9 application.

9

10

3.4.77 EF_{CDMACNL} (CDMA Co-operative Network List)

If service no°47 is allocated, this EF shall be present.

This EF contains the Co-operative Network List for the multiple network personalization services defined in [44].

Identifier: '6F6F'		Structure: transparent		Optional	
File size: 7n bytes			Update activity: low		
Access Conditions:					
READ		CHV1			
UPDATE		ADM			
INVALIDATE		ADM			
REHABILITATE		ADM			
Bytes	Description			M/O	Length
1 to 7	Element 1 of co-operative net list			M	7 bytes
7n-6 to 7n	Element n of co-operative net list			O	7 bytes

- Co-operative Network List

Contents:

Service provider ID and corporate ID of co-operative networks.

Coding:

For each 7 byte list element

Byte 1 to 3: MCC + MNC: As per ITU-T Recommendation E.212 Annex A.

Byte 4 to 5: 4 most significant digits of the International Roaming based MIN.

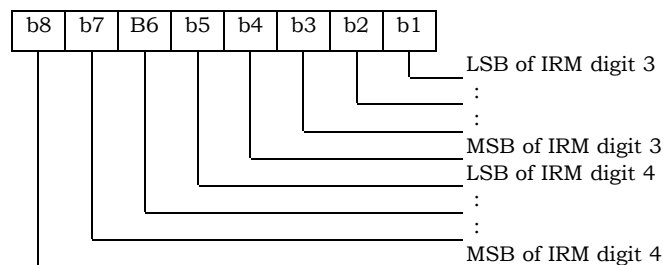
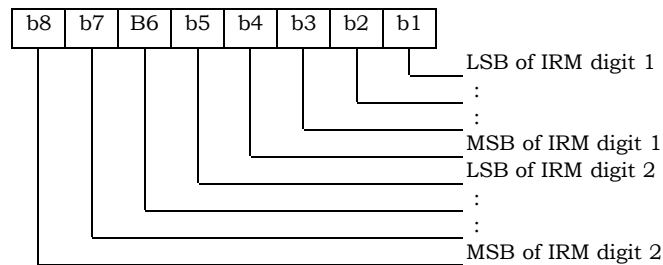

1

2

Byte 6:

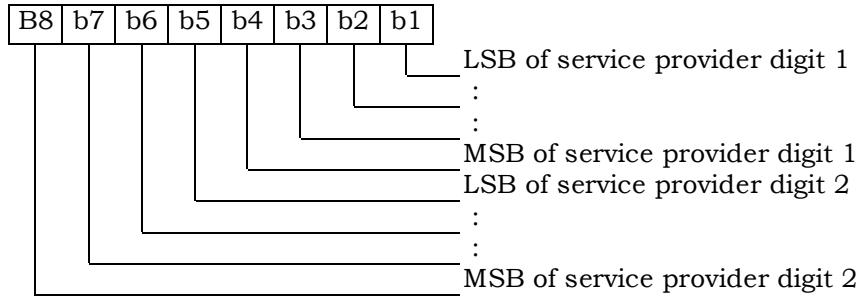

3

4

Byte 7:

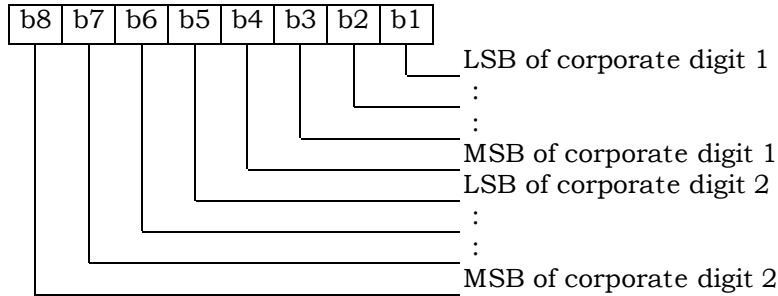

5

6

Empty fields shall be coded with 'FF'.

7

The end of the list is delimited by the first MCC field coded 'FFF'.

8

1 3.4.78 EF_{HOME_TAG} (Home System Tag)

2 This EF stores the Home System Tag, as described in Section 3.5.10.1 of [7].

3

Identifier: '6F70'		Structure: transparent		Mandatory	
File size: X bytes			Update activity: low		
Access Conditions:					
READ		CHV1			
UPDATE		ADM			
INVALIDATE		ADM			
REHABILITATE		ADM			
Bytes	Description	M/O	Length		
1 - X	Home System Tag (see Section 3.5.10.1 of [7])	M	Variable		

4

5

1 3.4.79 EF**GROUP_TAG** (Group Tag List)

2 This EF stores the Group Tag List, as described in Section 3.5.11 of [7].

3

Identifier: '6F71'		Structure: transparent		Mandatory	
File size: 'GROUP_TAG_LIST_SIZE'			Update activity: low		
Access Conditions:					
READ		CHV1			
UPDATE		ADM			
INVALIDATE		ADM			
REHABILITATE		ADM			
Bytes	Description	M/O	Length		
1- GROUP_T AG_LIST_ SIZE	Group Tag List (see Section 3.5.11 of [7])	M	Variable		

4

5

1 3.4.80 EF`SPECIFIC_TAG` (Specific Tag List)

2 This EF stores the Specific Tag List, as described in Section 3.5.11 of [7].

3

Identifier: '6F72'		Structure: transparent		Mandatory	
File size: 'SPEC_TAG_LIST_SIZE'			Update activity: low		
Access Conditions:					
READ		CHV1			
UPDATE		ADM			
INVALIDATE		ADM			
REHABILITATE		ADM			
Bytes	Description			M/O	Length
1- SPEC_TA G_LIST_SI ZE	Specific Tag List (see Section 3.5.11 of [7])			M	Variable

4

5

1

2 3.4.81 EF_{CALL_PROMPT} (Call Prompt List)

3 This EF stores the Call Prompt List, as described in Section 3.5.11 of [7].

4

Identifier: '6F73'		Structure: transparent		Mandatory	
File size: 'CALL_PRMPPT_LIST_SIZE'			Update activity: low		
Access Conditions:					
READ		CHV1			
UPDATE		ADM			
INVALIDATE		ADM			
REHABILITATE		ADM			
Bytes	Description	M/O	Length		
1- CALL_PR MPT_LIST _SIZE	Call Prompt List (see Section 3.5.11 of [7])	M	Variable		

5

6

1 3.4.82 EF_{SF_EUIMID} (Short Form EUIMID)

2 If service n^o8 is allocated, this file shall be present.

3
4 This EF stores the 56-bit electronic identification number (ID) unique to the R-UIM. *The*
5 *order of the digits when treated as 14 four-bit digits is shown in the table below, with ‘d1’*
6 *representing the leftmost/most significant digit and ‘d14’ representing the rightmost/least*
7 *significant digit.*

8
9

Identifier: ‘6F74’		Structure: transparent				Optional				
File size: 7 bytes				Update activity: low						
Access Conditions:										
READ		ALW								
UPDATE		Never								
INVALIDATE		Never								
REHABILITATE		Never								
Bytes	Description							M/O	Length	
1	Lowest order byte							M	1 byte	
2	÷							M	1 byte	
3	÷							M	1 byte	
4	÷							M	1 byte	
5	÷							M	1 byte	
6	÷							M	1 byte	
7	Highest order byte							M	1 byte	
Bytes	8	7	6	5	4	3	2	1	M/O	Length
1	d13				d14				M	1 byte
2	d11				d12				M	1 byte
3	d9				d10				M	1 byte
4	d7				d8				M	1 byte
5	d5				d6				M	1 byte
6	d3				d4				M	1 byte
7	d1				d2				M	1 byte

10

1 *3.4.83 EF_{ICCID} (ICC Identification)*

2 *EF_{ICCID} is defined in [18] with the following restrictions:*

- 3 • *This EF shall contain 18 digits of the actual ICCID followed by the check digit and a*
- 4 *single 0xF filler digit.*
- 5 • *The ICCID shall be globally unique, using an Issuer Identifier Number registered with*
- 6 *the ITU-T as specified in [47].*

7

3.5 Coding of Packet Data Security-Related Parameters

This section specifies the coding of packet data security-related parameters to be stored in the R-UIM securely. These parameters are used for IP based authentication functions by the R-UIM. Also, these parameters can be read or updated via OTA commands (i.e. 3GPD Configuration/Download Request command) only when the Secure Mode is turned on. If the R-UIM receives the 3GPD Configuration Request command or 3GPD Download Request command containing Block_ID for SimpleIP CHAP SS, MobileIP SS or HRPD Access Authentication CHAP SS Parameters Block and Secure Mode is not active, then the R-UIM shall return SW1='69' and SW2='82'.

3.5.1 SimpleIP CHAP SS Parameters

The SimpleIP CHAP SS Parameters shall be present if service n20 is allocated (See Section 3.4.18) and coded as follows:

Bytes	Description	Length
1	Length of SimpleIP CHAP SS Parameter Block	1 bytes
2 - X+1	See [7], SimpleIP CHAP SS Parameter Block	X bytes

Details of the SimpleIP CHAP SS Parameters Block are defined in Section 3.5.8.10 of [7].

3.5.2 MobileIP SS Parameters

The MobileIP SS Parameters shall be present if service n38 is allocated (See Section 3.4.18) and coded as follows:

Bytes	Description	Length
1	Length of MobileIP SS Parameter Block	1 bytes
2 - X+1	See [7], MobileIP SS Parameter Block	X bytes

Details of the MobileIP SS Parameters Block are defined in Section 3.5.8.11 of [7].

3.5.3 HRPD Access Authentication CHAP SS Parameters

The HRPD Access Authentication CHAP SS Parameters shall be present if service n5 is allocated (See Section 3.4.18) and coded as follows:

Bytes	Description	Length
1	Length of HRPD Access Authentication CHAP SS Parameters Block	1 bytes
2 - X+1	See [7], HRPD Access Authentication CHAP SS Parameters Block	X bytes

Details of the HRPD Access Authentication CHAP SS Parameters Block are defined in Section 3.5.8.14 of [7].

3.6 Coding of Shared Secret Used in IETF Protocol

This section specifies the coding of shared secret to be stored in the R-UIM securely, which is used in Authentication Function by the R-UIM.

The Shared Secret shall be present if service n40 is allocated (See Section 3.4.18) and coded as follows:

Bytes	Description	Length
1-2	Length of Shared Secret	2 bytes
3 – X+2	Shared Secret, see IETF RFCs in 3.4.72	X bytes

3.7 Multi-Mode Card

Multi mode card (e.g. CDMA and GSM) shall comply with both this document and [17]. In case of multi- mode mobile supporting multiple modes, if one mode fails to initialize, then the mobile shall attempt to initialize the other modes.

4 AUTHENTICATION AND SECURITY

This section describes the interface between the ME and the R-UIM. Details of the [15] protocols are provided in order to clarify the interface. Section 4.1 describes parameter storage and flow. Section 4.2 describes the components of [15]-based security procedures within the context of a R-UIM environment. Section 4.3 specifies detailed commands and responses between the ME and the R-UIM, and uses section 4.2 as a reference.

The authentication procedures may be tested using the test vectors from Section 3 of [20].

4.1 Parameter Storage and Parameter Exchange Procedures

The following parameters are stored on the R-UIM:

- Algorithm(s) for Authentication and Key Generation. Currently [15]-related security functions utilize the CAVE algorithm for these functions.
- A-key, which is accessible only to the algorithm used for Key Generation. The A-key may be programmed into the R-UIM directly by the service provider or it may be programmed into the R-UIM through an over-the-air procedure. The A-key is not accessible by the ME. Therefore the method of storage on the R-UIM is not specified in this document. During the execution of some procedures, it is necessary that two values (“old” and “new”) of the A-key be stored.
- Shared Secret Data (SSD), which is accessible only to the Authentication and Key Generation functions. SSD is not accessible by the ME. Therefore the method of storage on the R-UIM is not specified in the document. During the execution of some procedures, it is necessary that two values (“old” and “new”) of SSD be stored.
- Temporary (typically per-call) secret parameters used for the generation of ciphering keys subsequent to the authentication process.
- COUNT, accessible by the ME. COUNT is incremented upon network command.
- International Mobile Station Identity, consisting of both IMSI_M and IMSI_T. IMSI_M contains a Mobile Identification Number (MIN) in its lower 10 digits. IMSI_T is not related to the MIN. Subscription Identity is accessible by the ME.
- UIM_ID or pseudo-UIMID(if EUIM_ID is used), a parameter that is stored in EF_{RUIMID} having an identifier of ‘6F31’.
- Service Programming Code (SPC), having an identifier of ‘6F33’. SPC is used in the OTASP/OTAPA procedures.
- OTAPA/SPC_Enable, having an identifier of ‘6F34’. This stores the user’s input to the OTASP/OTAPA procedures.
- NAM_LOCK, having an identifier of ‘6F35’. This stores the lock/unlock status of the NAM.

- Root Key, which is accessible only to the algorithm used for Key Generation. The Root Key may be programmed into the R-UIM directly by the service provider or it may be programmed into the R-UIM through the procedures defined in [7]. The Root Key is not accessible by the ME. Therefore the method of storage on the R-UIM is not specified in this document. During the execution of some procedures, it is necessary that two values (“old” and “new”) of the Root Key be stored.

The following parameters are stored in the ME:

- All algorithms used for the encryption of voice, user data and signaling messages.
- Key-processing for ECMEA and ECMEA_NF functions.
- ME Electronic Serial Number (ESN).
- MEID
- Control mechanism for OTASP/OTAPA procedures

The following parameters are passed from the ME to the R-UIM during the course of security-related procedures:

- RAND, the “global” random challenge, available in the overhead information.
- Last Dialed Digits, a subset of the digits used to identify the called party. The R-UIM uses these to compose the “Auth Data” field for some ME messages. Refer to [14], Table 6.3.12.1-1, entitled “Auth_Signature Input Parameters”.
- RANDU, a “unique” random challenge sent by the network.
- AUTHBS, an authentication response sent from the network during the SSD Update process.
- RANDSeed, a random number that may be used to generate RANDBS.
- RANDSSD, the parameter that accompanies an SSD update command sent by the network to initiate an SSD update.
- ME Electronic Serial Number (ESN_ME), passed from the ME to the R-UIM upon insertion of the R-UIM into the ME if the ME has an ESN. Also it is sent in Run CAVE Command or Update SSD command. If UIM_ID Usage Indicator = ‘00’, the ESN value received in security command shall be used in authentication algorithm regardless of what is stored in EF_{ESNME} .
- ME Pseudo-ESN (if ESN is not available), the parameter that accompanies a Run CAVE Command or SSD update command.

The following parameters are passed from the ME to the R-UIM during the course of OTASP/OTAPA procedures:

- RANDSeed, a 32-bit random number that accompanies the OTAPA Request.

- 1 • RANDSeed, a 160-bit random number that is a parameter in the MS Key Request.
- 2 • A-key/Root Key generation parameters P, P Length, G, G Length, A-key Protocol
- 3 Revision, BS Result and BS Result Length.
- 4 • Block ID, Block Length, Parameter Data, Offset and Size parameters that refer to
- 5 stored data as components of Configuration, Validation and Download request
- 6 messages.
- 7 • Start/Stop indicator as part of OTAPA Request Message
- 8 • Pseudo-ESN, the parameter that accompanies the OTAPA Request command (if ME is
- 9 assigned with MEID and service n9 is allocated and activated)

10

11 The following parameters are passed from the R-UIM to the ME during the course of
 12 security-related procedures:

- 13 • AUTHR, the response to the “global challenge”.
- 14 • Keys, as needed, for use with the encryption algorithm(s). These may include a 64-
- 15 bit key and a variable length VPM.
- 16 • AUTHU, the response to a “unique” challenge.
- 17 • RANDBS, the network authentication challenge for the SSD Update procedure.

18

19 The following parameters are passed from the R-UIM to the ME during the course of
 20 OTASP/OTAPA procedures:

- 21 • RAND_OTAPA, for network validation.
- 22 • A-key/Root Key generation parameters MS Result and MS Result Length.
- 23 • Result Code for most commands to indicate success/failure and reason(s) for failure.
- 24 • Block ID, Block Length, Parameter Data, Offset and Size as needed to identify
- 25 segments of stored data.

26

4.2 Description of Security-Related Functions

The ME should start and finish the executions of all of the commands related to an [15] based security procedure in order and within the same Dedicated File (DF) environment.

The R-UIM performs the following operations; managing shared secret data, performing authentication calculations and generating encryption keys and managing the call history parameter.

4.2.1 Managing Shared Secret Data

The R-UIM stores and manages the SSD that is used as the derived secret variable for all authentication response calculations and subsequent key generations. SSD is derived from the “A-key” stored in the R-UIM. SSD updates are initiated when the network issues the command UPDATE SSD, containing the parameter RANDSSD, to the ME. Details of the SSD update procedure are described in [14] and other EIA/TIA air interface documents.

A subscriber’s home network is the only entity that may update the subscriber’s Shared Secret Data (SSD). This is illustrated in Figure 4.2.1-1. When the network launches an SSD Update to a particular subscriber, the subscriber’s ME will first store the parameter RANDSSD and then generate a random number called RANDSeed. The ME begins the Base Station Challenge function by passing the parameter RANDSeed to the R-UIM. This in turn causes the R-UIM to generate RANDBS. The relationship of RANDBS to RANDSeed is specified by the issuer of the R-UIM. The R-UIM may derive RANDBS by applying a pseudo-random process to RANDSeed, or it may ignore RANDSeed and generate RANDBS independently. RANDBS should not be the same for consecutive identical values of RANDSeed. The command Base Station Challenge directs the R-UIM to pass RANDBS to the ME, which in turn forwards RANDBS to the network.

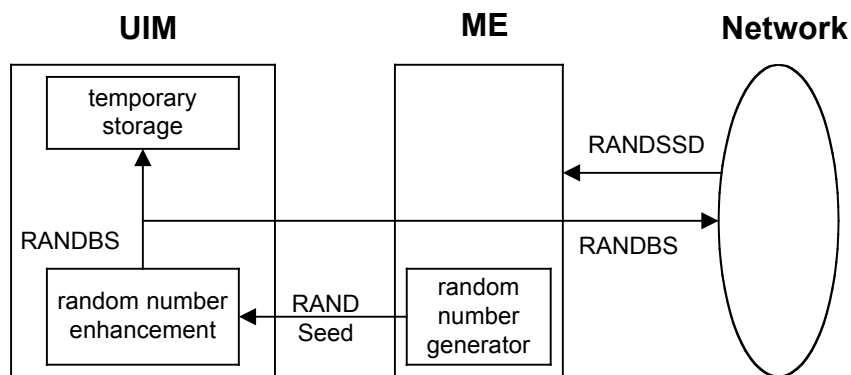

Figure 4.2.1-1. Base Station Challenge Function

Next, the ME updates SSD by sending the Update SSD command to the R-UIM, containing the parameter RANDSSD and a control data field. Refer to Figure 4.2.1-2. The R-UIM then calculates a new (trial) value of SSD and calculates an expected value of the

network's response to RANDBS, called AUTHBS. The parameters ESN and IMSI used for these calculations are determined at the time of R-UIM insertion into the ME in accordance with EF 6F42. If ESN rather than UIMID is chosen (i.e. UIM_ID Usage Indicator = '00'), the value used as input to authentication algorithms shall be the one received from security commands, regardless of what is stored in EF_{ESN_ME}. For details, refer to section 4.6, "ESN and MEID Management Command", and to section 3.4.2, "EF IMSI_M".

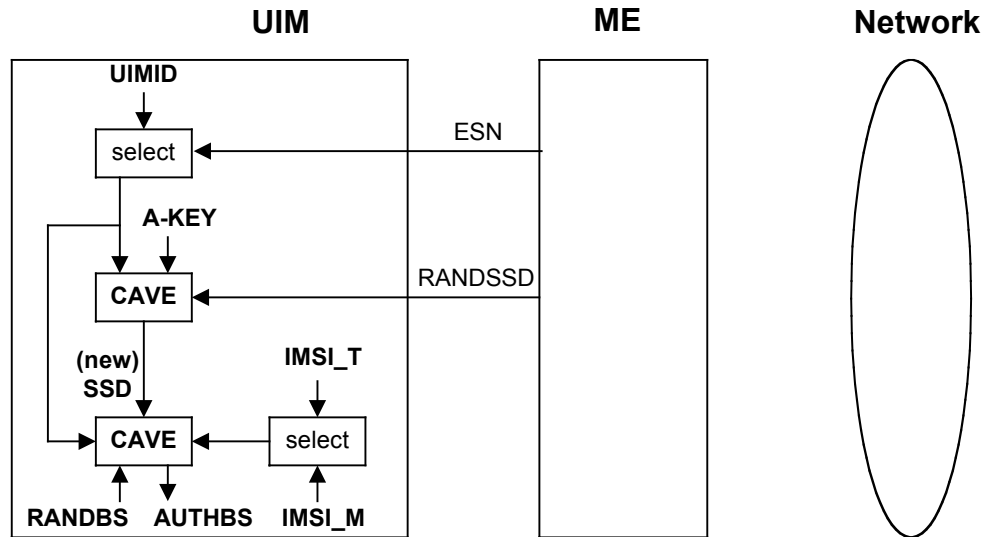

Figure 4.2.1-2. Update SSD Function, AUTHBS Calculation

In the network, the parameter RANDSSD is also used to generate a new value of SSD for the selected R-UIM. When RANDBS is received from the subscriber's ME, the network combines it with the new SSD to calculate AUTHBS. AUTHBS is then sent from the network to the subscriber's phone. Refer to Figure 4.2.1-3. The ME in turn forwards the received value of AUTHBS to the R-UIM as a parameter of the Confirm SSD function. The R-UIM then compares its calculated value of AUTHBS to that sent by the network.

If the R-UIM finds the two values to be equivalent, the SSD Update procedure has been a success. The new value of SSD is then stored in semi-permanent memory on the R-UIM and used for all subsequent authentication calculations, with one exception, noted below. If the two values of AUTHBS are different, the R-UIM discards the new SSD and continues to retain its current value. Refer to Figure 4.2.1-3.

If the SSD Update procedure is being performed as part of an OTASP/OTAPA procedure, the ME shall set "process control" bit 2 to the value of '1' as an input parameter of the "Update SSD" command. This will cause the R-UIM to retain the current value of SSD in semi-permanent memory but use the new value for re-authentication calculations. The R-UIM will set the value of SSD to the new value only upon R-UIM acceptance of the "Commit Request Message" from the network.

1

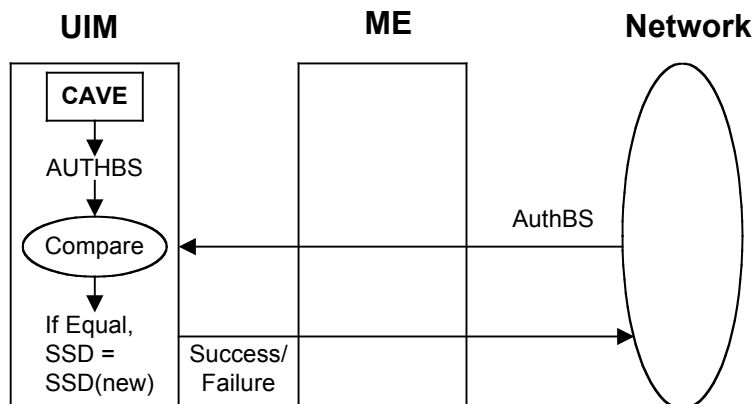

2

3

Figure 4.2.1-3. Confirm SSD Function

4

4.2.2 Performing Authentication Calculations and Generating Encryption Keys

5

The second R-UIM security-related function is to perform authentication calculations and generate encryption keys for use with ME ciphering techniques. See Figure 4.2.2-1. This is performed by the Run CAVE function. The settings of the input parameters for the authentication procedure are defined in [5] and [14]. The parameters ESN and IMSI that are used for the Run CAVE function are determined at the time of R-UIM insertion into the ME. If ESN rather than UIMID is chosen (i.e. UIM_ID Usage Indicator = '00') for the Run CAVE function, the value used for the CAVE algorithm shall be the one received from security commands, regardless of what is stored in EF_{ESN_ME} . For details, refer to section 4.6, "ESN and MEID Management Command", and to section 3.4.2, "EF IMSI_M".

14

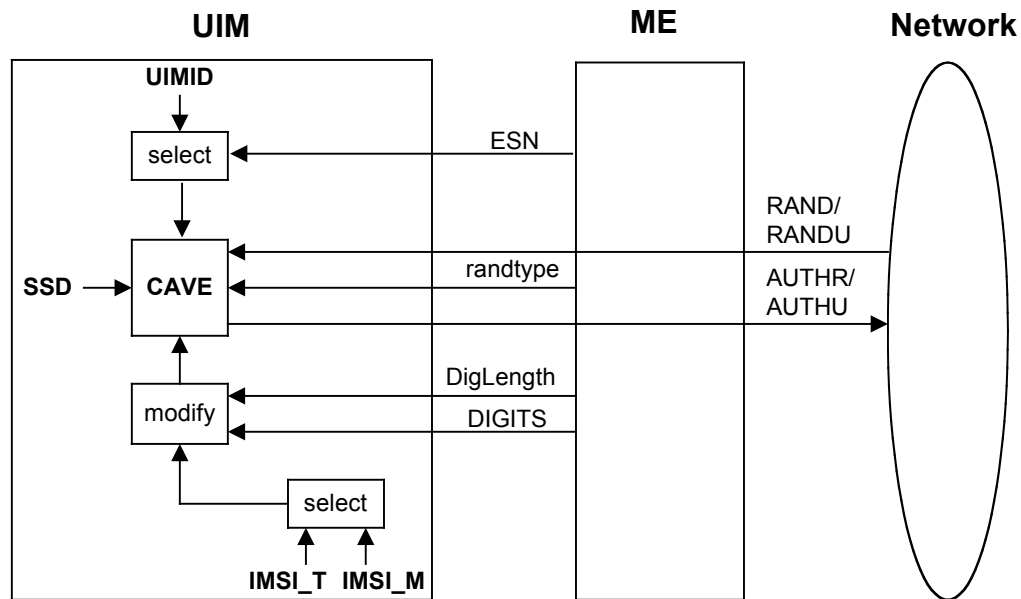

1
2
3
4
5
6
7
8
9
10
11
12
13
14
15
16
17
18
19
20
21
22
23
24
25
26
27

Figure 4.2.2-1. Run CAVE Function

The R-UIM stores both an IMSI_M and an IMSI_T to identify the subscription. The lower 10 digits of each are encoded as 34 bit subsets identified as IMSI_M_S and IMSI_T_S, respectively. These are further subdivided into the 24-bit quantities IMSI_M_S1 and IMSI_T_S1 to identify the coding of the lower 7 digits and the 10-bit quantities IMSI_M_S2 and IMSI_T_S2 to identify the coding of the remaining 3 digits. For the authentication calculation, the 24-bit coding of the lower 7 digits is used for most applications. Furthermore, an 8-bit subset of the coding of the remaining 3 digits may also be used. See Table 6.3.12.1-1 in [14], entitled “Auth_Signature Input Parameters”. The IMSI to be used for these calculations is determined at the time of R-UIM insertion into the ME. For details, refer to section 3.4.2, “EF IMSI_M”.

In order that conformance to [14] be supported, a 34-bit MIN will be stored in EF IMSI_M. The use of these bits for the calculation of authentication responses shall be as described above.

The command Get Response causes the R-UIM to pass the output AUTHR or AUTHU (“global” challenge response or “unique” challenge response) to the ME. Temporary parameters may be stored on the R-UIM for use in calculating ciphering keys.

The calculation of ciphering keys is performed by execution of the Generate Key/VPM function.

The Generate Key/VPM function is shown in Figure 4.2.2-2. This function will produce keys for some of the ciphering mechanisms as specified in [14]. Generate Key/VPM will process temporary stored parameters that were produced during the calculation of an authentication response by the Run CAVE function and will produce keys. Some may be used directly for ME encryption functions and some may be further processed within the ME for use by the ECMEA and ECMEA_NF encryption functions.

1

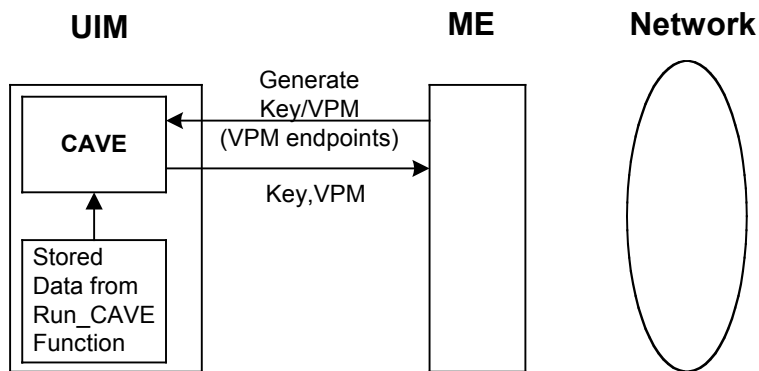

2

3

Figure 4.2.2-2. Generate Key/VPM Function

4

5 **4.2.3 Managing the Call History Parameter**

6 The third security-related function is the generation and management of the call history
 7 parameter CALL COUNT. CALL COUNT is used as a simple “clone” detector. During
 8 network access protocols, the R-UIM reports its value of CALL COUNT to the network. If
 9 the value is consistent with the network’s perception of CALL COUNT, the network will
 10 likely grant access based on the authentication process. During the call, the value of
 11 CALL COUNT may be incremented upon a command from the network.

12 If the network determines that a value of CALL COUNT appears to be out of sequence, the
 13 network may choose to investigate the possibility that the R-UIM has been “cloned” and
 14 take remedial action.

15 Incrementing and reading the parameter COUNT is accomplished via standard ME-to-R-
 16 UIM commands.

17

1 **4.3 Description of OTASP/OTAPA Functions**

2 A complete description of Over-the-Air Service Provisioning (OTASP) and Over-the-Air
3 Parameter Administration (OTAPA) may be found in [7]. This section highlights the
4 aspects of R-UIM that support OTASP/OTAPA. EFs are described first, followed by [7]
5 “Request/Response” messages that have been mapped to R-UIM commands. In some
6 cases, ME intervention is necessary to accomplish the OTASP/OTAPA functions.

7 4.3.1 Elementary Files for OTASP/OTAPA

8 Four EFs are described.

9 4.3.1.1 EF_{SPC} (Service Programming Code)

10 The Service Programming Code (SPC) is a simple means to protect the contents of the R-
11 UIM from being programmed without authorization. SPC is described in [7] section 3.3.6.

12 4.3.1.2 EF_{OTAPASPC} (OTAPA/SPC_Enable)

13 This EF can be written to and read via the ME. It allows the user to activate OTAPA
14 protection for the NAM on the R-UIM. It also allows the user to enable (or deny) over-the-
15 air changes to be made to his SPC.

16 4.3.1.3 EF_{NAMLOCK} (NAM_LOCK)

17 [7] provides means for “locking” NAM contents under the control of the service provider,
18 with appropriate inputs from the user. This EF stores the current state (locked/unlocked)
19 of the NAM.

20 4.3.1.4 EF_{OTA} (OTASP/OTAPA Features)

21 This EF maintains a listing of OTASP/OTAPA features and the associated protocol version
22 for each. The ME reads this EF in order to respond to the “Protocol Capability Request
23 Message” from the network. The ME combines this information with parameters, such as
24 model number, that are stored in the ME.

25 4.3.2 Mapping of OTASP/OTAPA Request/Response Messages to R-UIM Commands

26 Eleven (11) OTASP/OTAPA message pairs are listed in [7]. In some cases, the mapping is
27 one-to-one. In others, the ME intervenes by performing a translation to enable the use of
28 simple R-UIM commands. In still other cases, the ME relies upon security-related
29 commands to prepare a response.

30 4.3.2.1 Protocol Capability Request/Response Messages

31 This message requests information that is stored in both the ME and in the R-UIM. The
32 ME reads the EF “OTASP/OTAPA Features” in order to format the “features” component of
33 the response, then adds information stored in the ME in order to complete the response.

34

1 4.3.2.2 MS Key Request/Response Messages

2 This is the command that causes the R-UIM to generate its private and public key pair.
3 This key pair is intended for use in a subsequent Diffie/Hellman key exchange that
4 enables calculation of the “A-key” and/or Root Key. Upon receipt of the MS Key Request
5 message from the network, the ME generates a 160-bit random number called RANDSeed
6 and sends RANDSeed to the R-UIM along with the modulus P and the generator G sent by
7 the network. The R-UIM in turn generates a random number x that may be related to
8 RANDSeed. Then the R-UIM raises G to the x power, modulo P and temporarily stores the
9 result as MS_RESULT. The R-UIM computes a “Result Code” and sends this in response to
10 the MS Key Request message. The ME forwards the Result Code to the network to
11 complete this transaction.

12 4.3.2.3 Key Generation Request/Response Messages

13 This request/response pair completes the Diffie/Hellman key exchange. The network
14 sends BS_RESULT to the R-UIM and the R-UIM in turn sends MS_RESULT to the network.
15 The R-UIM calculates the Diffie/Hellman result by raising BS_RESULT to the x power,
16 modulo P. A subset of this result is temporarily stored as the A-key and/or Root Key.
17 Details of this process are in [7], section 5.1.

18 4.3.2.4 SSD Update

19 An SSD Update may be performed as a component of OTASP/OTAPA procedures. This
20 process uses commands and EFs described in other sections of the R-UIM document. The
21 SSD Update procedure that is performed during OTASP/OTAPA uses temporary values of
22 the A-Key and SSD, and does not store these temporary values in semi-permanent
23 memory until the R-UIM accepts the “Commit Request Message”. This slight deviation
24 from the [14] procedure is accommodated by the setting of “bit 2” of the “process control”
25 parameter of the “Update SSD” command to the R-UIM. The R-UIM should reject any
26 Update SSD command and return SW1='98' and SW2='34' if it is received outside of the
27 context of a key generation procedure.

28 4.3.2.5 Re-Authentication Request/Response Messages

29 The ME receives the Re-Authentication Request Message containing the four-octet
30 parameter RAND. The ME constructs the Re-Authentication Response Message by taking
31 the following steps.

- 32 (1) Read EF COUNT
- 33 (2) Prepare AUTH_DATA (See [7], section 3.3.2)
- 34 (3) Truncate RAND to produce RANDC
- 35 (4) Compute AUTHR by using the command Run CAVE with input parameters:
 - 36 • RANDTYPE='0000 0000' (i.e., 32 bits)
 - 37 • RAND=RAND received by ME

- 1 • DigLength, DIGITS as specified by AUTH_DATA
- 2 • Process Control
- 3 Bit0: '0' (inactive)
- 4 Bit1: '0' (inactive)
- 5 Bit2: '1' (wait for Commit before storing A-key, SSD)
- 6 Bit3: '0' (inactive)
- 7 Bit4: '1' (save registers)
- 8 Bit5: '0' (inactive)
- 9 Bit6: '0' (inactive)
- 10 Bit7: '0' (inactive)

11

12 If message encryption or voice privacy is to be activated, the ME executes the command
13 Generate Key/VPM with the R-UIM.

14

1 4.3.2.6 Validation Request/Response Messages

2 The ME receives the Validate Request Message, which seeks validation of 'NUM_BLOCKS'
3 blocks of data, each block having a length of 'BLOCK_LEN'. In order that R-UIM command
4 coding be simplified, the ME buffers the data into respective blocks, then validates each
5 block via the command Validate, whereby a single block of data having length
6 'BLOCK_LEN' is validated. For each block, the R-UIM responds with a Result Code. The
7 ME then accumulates the R-UIM responses and sends a composite response to the
8 network.

9 [7] Section 4.5.4 describes common blocks of data that are validated. These include
10 verification of the SPC, verification that the SPC may be updated by the network and
11 validation of SPASM, whereby AUTH_OTAPA is compared within the R-UIM to an
12 internally-generated value that was calculated as a component of the R-UIM's response to
13 the OTAPA Request command. Thus, the SPASM mechanism requires that an OTAPA
14 Response Message be sent from ME to network prior to the Validation Request message.

15 4.3.2.7 Configuration Request/Response Messages

16 The ME receives the Configuration Request Message, which requests configuration details
17 of 'NUM_BLOCKS' of data, each block having a length of 'BLOCK_LEN'. In order that R-UIM
18 command coding be simplified, the ME buffers the request into 'NUM_BLOCK' single block
19 requests, then asks for configuration details for each block via the Configuration Request
20 command to the R-UIM. For each block, the R-UIM responds with the Block ID, Block
21 Length, Result Code and Parameter Data. The ME accumulates the set of block responses
22 and sends a composite response to the network. Note that the R-UIM shall use ME-specific
23 parameters (i.e. SCM, MOB_P_REV and Local Control) stored in the EF_{MECRP} to generate a
24 response.

25 4.3.2.8 Download Request/Response Messages

26 The ME receives the Download Request Message, which attempts to download
27 'NUM_BLOCKS' of data to the R-UIM, each block having a Block ID, Block Length and
28 Parameter Data of length 'Block Length'. In order that R-UIM command coding be
29 simplified, the ME buffers the request into NUM_BLOCK single block requests, then
30 attempts to download each block via the Download Request command to the R-UIM. Prior
31 to issuance of multiple Download Request commands, the ME may query appropriate EF
32 data to determine if adequate storage space exists in the R-UIM EFs to successfully
33 complete the downloading operation. For each execution of the Download Request
34 command, the R-UIM returns the Block ID and Result Code. The ME accumulates the set
35 of block responses and sends a composite response to the network.

36 4.3.2.9 SSPR Configuration Request/Response Messages

37 The network asks for SSPR data stored in a particular area of the R-UIM. The R-UIM
38 responds with Block ID, Result Code, Block Length and Parameter Data. The ME is
39 transparent to this operation. Parameters are formatted as in [7].

1 4.3.2.10 SSPR Download Request/Response Messages

2 The network attempts to download SSPR data into the R-UIM. The data contains a Block
3 ID, a Block Length and Parameter Data having 'Block Length' size. The R-UIM responds
4 with the Block ID, Result Code, Segment Offset and Segment Size, as described in [7],
5 sections 4.5.1.9 and 3.5.1.9. The ME is transparent to this operation.

6 4.3.2.11 OTAPA Request/Response Messages

7 The network attempts to initiate OTAPA by sending an "OTAPA Request Message"
8 containing the "start/stop" parameter. The ME in turn passes this to the R-UIM, along
9 with a 32-bit ME-generated random number RANDSeed. If service n9 is allocated and
10 activated and ME is assigned with MEID, the ME also passes pseudo-ESN to the R-UIM.
11 The R-UIM generates its own random number RAND_OTAPA which may be related to
12 RANDSeed. Also, the R-UIM computes a value for AUTH_OTAPA as described in [7],
13 section 3.3.7. The input parameter "ESN" described in section 3.3.7 shall be set to the
14 "ESN" parameter field used for air interface access messages (e.g., origination, registration,
15 termination). The R-UIM passes RAND_OTAPA, a Result Code and NAM_LOCK indication
16 to the ME, which re-formats the data and sends it to the network.

17 4.3.2.12 Commit Request/Response Messages

18 The network sends a "Commit Request Message" to the R-UIM via the ME. The ME
19 translates this to the R-UIM command Commit. The R-UIM responds with the Result Code
20 which the ME forwards to the network via the "Commit Response Message".

21 4.3.2.13 PUZL Configuration Request/Response Messages

22 The network asks for PUZL data stored in a particular area of the R-UIM. The R-UIM
23 responds with Block ID, Result Code, Block Length and Parameter Data. The ME is
24 transparent to this operation. Parameters are formatted as in [7].

25 4.3.2.14 PUZL Download Request/Response Messages

26 The network attempts to download PUZL data into the R-UIM. The data contains a Block
27 ID, a Block Length and Parameter Data having 'Block Length' size. The R-UIM responds
28 with the Block ID, Result Code, Identifier Present Flag, User Zone ID and User Zone
29 System ID, as described in [7], sections 4.5.1.13 and 3.5.1.13. The ME is transparent to
30 this operation.

31 4.3.2.15 3GPD Configuration Request/Response Messages

32 The ME receives the 3GPD Configuration Request Message which requests configuration
33 details of 'NUM_BLOCKS' of data with each block having a length of 'BLOCK_LEN'. In order
34 that R-UIM command coding be simplified, the ME buffers the request into 'NUM_BLOCK'
35 single block requests, then asks for configuration details for each block via the 3GPD
36 Configuration Request command to the R-UIM. For each block, the R-UIM responds with
37 the Block ID, Block Length, Result Code and Parameter Data. The ME accumulates the
38 set of block responses and sends a composite response to the network. If the 3GPD

1 Configuration Request command contains a BLOCK_ID for SimpleIP CHAP SS Parameters,
2 MobileIP SS Parameters or HRPD Access Authentication CHAP SS Parameters, the R-UIM
3 shall check if the Secure Mode is active. If the Secure Mode is not active, then the R-UIM
4 shall return SW1='69' and SW2='82'

5 4.3.2.16 3GPD Download Request/Response Messages

6 The ME receives the 3GPD Download Request Message which attempts to download
7 'NUM_BLOCKS' of data to the R-UIM, each block having a Block ID, Block Length and
8 Parameter Data of length 'Block Length'. In order that R-UIM command coding be
9 simplified, the ME buffers the request into NUM_BLOCK single block requests, then
10 attempts to download each block via the 3GPD Download Request command to the R-UIM.
11 The ME may query appropriate EF data to determine if adequate storage space exists in
12 the R-UIM EFs to successfully complete the downloading operation, prior to issuance of
13 multiple Download Request commands. For each execution of the 3GPD Download
14 Request command, the R-UIM returns the Block ID and Result Code. The ME accumulates
15 the set of block responses and sends a composite response to the network. If the 3GPD
16 Download Request command contains a BLOCK_ID for SimpleIP CHAP SS Parameters,
17 MobileIP SS Parameters or HRPD Access Authentication CHAP SS Parameters, the R-UIM
18 shall check if the Secure Mode is active. If the Secure Mode is not active, then the R-UIM
19 shall return SW1='69' and SW2='82'

21 4.3.2.17 Secure Mode Request/Response Messages

22 This is the command that causes the R-UIM to generate Secure Mode Ciphering Key
23 (SMCK). The R-UIM shall use the SMCK as a key for encryption and decryption of all
24 PARAM-DATA of all Parameter Blocks sent and received by the R-UIM in the OTASP Data
25 Messages while the Secure Mode is active.

26 The network can initiate the Secure Mode by sending Secure Mode Request Message to
27 the ME with the START_STOP field set to '1'. Upon receipt of the Secure Mode Request
28 Message with the START_STOP field set to '1', the ME translates this to the Secure Mode
29 command. The R-UIM shall use RAND_SM received in this command and the SSD to
30 compute the SMCK as described in [7], section 3.3.8.1 and then the R-UIM responds with
31 Result Code, which the ME forwards to the network via the "Secure Mode Response
32 Message". While the Secure Mode is active, the ME shall send FRESH command to the R-
33 UIM prior to send any commands when it receives one of the following messages;

- 34 • Configuration Request Messages
- 35 • SSPR Configuration Request Message
- 36 • PUZL Configuration Request Message
- 37 • 3GPD Configuration Request Message
- 38 • Download Request Messages
- 39 • SSPR Download Request Message

- 1 • PUZL Download Request Message
- 2 • 3GPD Download Request Message
- 3 • MMD Configuration Request Message
- 4 • MMD Download Request Message
- 5 • MMS Configuration Request Message
- 6 • MMS Download Request Message
- 7 • System Tag Configuration Request Message
- 8 • System Tag Download Request Message

9 For the configuration request messages, the ME sends the FRESH command to R-UIM to
 10 request a 15-bit FRESH value selection. This can be selected at random or can be set to a
 11 monotonically increasing counter. The R-UIM responds with the FRESH value.

12 For the download request messages, the ME sends the FRESH command to R-UIM to pass
 13 the FRESH value received from the network.

14 The network can terminate the Secure Mode by sending Secure Mode Request Message
 15 to the ME with the START_STOP field set to '0'. Upon receipt of the Secure Mode Request
 16 Message with the START_STOP field set to '0', the ME translates this to the Secure Mode
 17 command. The R-UIM responds with Result Code, which the ME forwards to the network
 18 via the "Secure Mode Response Message".

19 4.3.2.18 Service Key Generation Request/Response Messages

20 This is the command that causes the R-UIM to generate Service keys, such as BCMCS,
 21 IMS, WLAN, etc. R-UIM shall generate an intermediate key based on the root key before
 22 using it to generate service keys. Details of this process are in [7], section 3.3.10.

23 4.3.2.19 MMD Configuration Request/Response Messages

24 The network asks for MMD data stored in a particular area of the R-UIM. The R-UIM
 25 responds with Block ID, Result Code, Block Length and Parameter Data. The ME is
 26 transparent to this operation. Parameters are formatted as in [7].

27 4.3.2.20 MMD Download Request/Response Messages

28 The network attempts to download MMD data into the R-UIM. The data contains a Block
 29 ID, a Block Length and Parameter Data having 'Block Length' size. The R-UIM responds
 30 with the Block ID and Result Code as described in [7], sections 4.5.1.19 and 3.5.1.19. The
 31 ME is transparent to this operation.

32

1 4.3.2.21 MMS Configuration Request/Response Messages

2 The network asks for MMS data stored in a particular area of the R-UIM. The R-UIM
3 responds with Block ID, Result Code, Block Length and Parameter Data. The ME is
4 transparent to this operation. Parameters are formatted as in [7].

5 4.3.2.22 MMS Download Request/Response Messages

6 The network attempts to download MMS data into the R-UIM. EF_{MMSICP} (MMS Issuer
7 Connectivity Parameters) should be updated. The data contains a Block ID, a Block
8 Length and Parameter Data having 'Block Length' size. The R-UIM responds with the Block
9 ID and Result Code as described in [7], sections 4.5.1.24 and 3.5.1.24. The ME is
10 transparent to this operation.

11 4.3.2.23 System Tag Configuration Request/Response Messages

12 The network asks for System Tag data stored in a particular area of the R-UIM. The R-UIM
13 responds with Block ID, Result Code, Block Length and Parameter Data. The ME is
14 transparent to this operation. Parameters are formatted as in [7].

15 4.3.2.24 System Tag Download Request/Response Messages

16 The network attempts to download System Tag data into the R-UIM. The data contains a
17 Block ID, a Block Length and Parameter Data having 'Block Length' size. The R-UIM
18 responds with the Block ID, Result Code, Segment Offset and Segment Size, as described
19 in [7]. The ME is transparent to this operation.
20

4.4 Description of Security-Related Commands

The commands Base Station Challenge, Update SSD and Confirm SSD are performed in sequence. If either Update SSD or Confirm SSD are run out of sequence, the card shall return SW1='98' and SW2='34'. If T=0 protocol is used, APDU is mapped onto TPDU (see Section 9.1 in [17])

In the procedures described in Sections 4.4.1 through 4.4.5; RANDSSD, RANDSeed, RANDBS, AuthBS, RAND, RANDU, AUTHR and AUTHU are encoded with the highest-order byte first. ESN is encoded with the lowest-order byte first to match the coding for EF_{ESN-ME}.

4.4.1 Update SSD

COMMAND	CLASS	INS	P1	P2	Lc	Le
UPDATE SSD	'A0'	'84'	'00'	'00'	'0F'	'00'

Command parameters/data:

Octet(s)	Description	Length
1 – 7	RANDSSD	7 bytes
8	Process_Control*	1 byte
9 – 15	ESN	7 bytes

The input parameter Process_Control is coded as follows:

The least significant bit (bit 0) is reserved for future use.

The next-least significant bit (bit 1) is reserved for future use.

Bit 2 of Process_Control specifies the trigger that causes newly-calculated values of SSD to become stored in semi-permanent memory.

'000x 0000' successful validation of AUTHBS via Confirm SSD command

'000x 0100' upon acceptance of a Commit Request Message command during OTASP/OTAPA

Bit 3 of Process_Control is reserved for future use.

Bit 4 specifies the need to save registers:

'0001 0x00' save registers ON

'0000 0x00' save registers OFF

If save registers is set (to ON) this causes the authentication process to maintain or "freeze" the state of internal registers following the generation of an authentication response.

The use of bit 4 is only relevant to the Run CAVE command, in which the generation of keys may follow the generation of an authentication response.

Bits 5-7 of Process_Control are reserved for future use.

If the ME is assigned with MEID, Pseudo-ESN value shall be used in ESN field. If EF_{USGIND} bit 1 is set to 0, then the R-UIM shall use the value in ESN field as an input to CAVE algorithm.

4.4.2 Base Station Challenge

COMMAND	CLASS	INS	P1	P2	Lc	Le
BASE STATION CHALLENGE	'A0'	'8A'	'00'	'00'	'04'	'04'

Command parameters/data:

Octet(s)	Description	Length
1 – 4	RANDSeed	4 bytes

Response parameters/data:

Octet(s)	Description	Length
1 – 4	RANDBS	4 bytes

4.4.3 Confirm SSD

COMMAND	CLASS	INS	P1	P2	Lc	Le
CONFIRM SSD	'A0'	'82'	'00'	'00'	'03'	empty

Command parameters/data:

Octet(s)	Description	Length
1 – 3	AuthBS	3 bytes

Response parameters/data:

No response parameters are generated as a result of command execution. Successful comparison will cause SW1 to be set to '90' and SW2 to be set to '00'. Unsuccessful comparison will cause SW1 to be set to '98' and SW2 to be set to '04'.

If the ME is assigned an MEID and if bit1 of the EF_{USGIND} is set to '0', then the Pseudo-ESN value received in the Update SSD command shall be used in ESN field as input to CAVE algorithm for the computation of AuthBS

4.4.4 Authenticate

This command performs authentication functions.

COMMAND	CLASS	INS	P1	P2	Lc	Le
Authenticate	'A0'	'88'	P1	'00'	'XX'	'YY'

P1 parameter defines the authentication command type:

P1	Meaning
'00'	Run CAVE
'01'	3G Access AKA
'02'	EAP AKA

P1='00': 2G Authentication-Run CAVE

Command parameters/data:

Octet(s)	Description	Length
1	RANDTYPE (RAND/RANDU)	1 byte
2 - 5	RAND/RANDU	4 bytes
6	DigLength (expressed in bits)	1 byte
7 - 9	DIGIT	3 bytes
10	Process_Control	1 byte
11 - 17	ESN	7 bytes

The parameter RANDTYPE is coded as follows:

'0000 0000' RAND (global random challenge)

'0000 0001' RANDU (unique random challenge)

All other values of RANDTYPE are reserved for future use.

If the RANDTYPE is set to RAND, then the RAND occupies octets 2-5. If the RANDTYPE is set to RANDU, then the RANDU occupies octets 3-5 and octet 2 is ignored.

If there are no DIGITS for input to CAVE (e.g., for Registration or Unique Challenge), then DigLength = 0 and Octets 7-9 = 0. If DIGITS are included, bits b1 to b4 of Octet 9 encode the least significant digit of DIGITS, the next least significant digit is encoded in bits b5 to b8 of Octet 9, the next least significant digit is encoded in bits b1 to b4 of Octet 8 and so on to Octet 7. If less than 6 digits are input, then bytes 7-9 are zero padded. For example, if the digits are "123", then

Byte 6 = 0000 1100,

1 Byte 7 = 0000 0000,

2 Byte 8 = 0000 0001 and

3 Byte 9 = 0010 0011.

4 If the ME is assigned with MEID, Pseudo-ESN value shall be used in ESN field. If EF_{USGIND} bit
5 1 is set to 0, then the R-UIM shall use the value in ESN field as an input to CAVE
6 algorithm.

7
8 Response parameters/data:

Octet(s)	Description	Length
1 - 3	AUTHR/AUTHU	3 bytes

9
10 The input parameter Process_Control is coded as follows:

11 The least significant bit (bit 0) is reserved for future use.

12 The next-least significant bit (bit 1) is reserved for future use.

13 Bit 2 of Process_Control specifies the trigger that causes newly-calculated values of SSD to
14 become stored in semi-permanent memory.

15 '000x 0000' successful validation of AUTHBS via Confirm SSD command

16 '000x 0100' upon acceptance of a Commit Request Message command

17 during OTASP/OTAPA

18 Bit 3 is reserved for future use and shall be set to '0'.

19 Bit 4 specifies the need to save registers:

20 '0001 0x00' save registers ON

21 '0000 0x00' save registers OFF

22 If save registers is set (to ON) this causes the authentication process to maintain or
23 "freeze" the state of internal registers following the generation of an authentication
24 response.

25 The use of bit 4 is only relevant to the Run CAVE command, in which the generation of
26 keys may follow the generation of an authentication response.

27 Bit 5 is reserved for future use and shall be set to '0'.

28 Bits 6 and 7 of Process_Control are reserved for future use and shall be set to '0'.

29
30 P1='01': 3G Authentication-AKA

31 Upon receiving this command, the R-UIM either generates IK, CK, RES, UAK if supported,
32 by using Root Key or sends an AUTS if sequence number resynchronization is necessary.
33

1 Command parameters/data:

Octet(s)	Description	Length
1-16	RANDA	16 bytes
17	Length of AUTN (L1)	1 byte
18-18+L1	AUTN	L1 bytes

2 Where AUTN = SQN⊕AK | |AMF| |MAC-A

3 Response parameters/data:

Octet(s)	Description	Length
1	Synchronization Failure Tag	1 byte

Either

2 – 17	Cipher Key	16 bytes
18 – 33	Integrity Key	16 bytes
34	RES Length	1 byte
35 to 35+RES Length-1	RES	RES Length

Or

2-15	AUTS	14 bytes
------	------	----------

4
5 If the R-UIM detects the sequence numbers to be invalid, the R-UIM shall set
6 synchronization failure tag to '00000001' and include AUTS. Otherwise, the R-UIM shall
7 set synchronization failure tag to '00000000' and include CK, IK, RES Length and RES. All
8 the other values are reserved.

9 If MACA comparison fails, the R-UIM returns **status words SW1 = '98' and SW2 = '04'**.

10 RES Length field shall be set to the length of RES, and it has to be greater or equal to 1.

11 P1='02': WLAN Authentication-AKA

12 Upon receiving this command, the R-UIM either generates IK, CK, RES, UAK if supported,
13 by using WLAN Root Key or sends an AUTS if sequence number resynchronization is
14 necessary.
15

16 Command parameters/data:

Octet(s)	Description	Length
1-16	RANDA	16 bytes
17	Length of AUTN (L1)	1 byte
18-18+L1	AUTN	L1 bytes

17 Where AUTN = SQN⊕AK | |AMF| |MAC-A

18 Response parameters/data:

Octet(s)	Description	Length
1	Synchronization Failure Tag	1 byte
Either		
2 – 17	Cipher Key	16 bytes
18 – 33	Integrity Key	16 bytes
34	RES Length	1 byte
35 to 35+RES Length-1	RES	RES Length
Or		
2-15	AUTS	14 bytes

1
2 If the R-UIM detects the sequence numbers to be invalid, the R-UIM shall set
3 synchronization failure tag to '00000001' and include AUTS. Otherwise, the R-UIM shall
4 set synchronization failure tag to '00000000' and include CK, IK, RES Length and RES. All
5 the other values are reserved.

6 If MACA comparison fails, the R-UIM returns status words SW1 = '98' and SW2 = '04'.

7 RES Length field shall be set to the length of RES, and it has to be greater or equal to 1.

8 4.4.4.1 Advisory Note on the Use of Run CAVE

9 In early versions of R-UIM specifications, the Run CAVE command was used to perform
10 both the calculations of authentication responses and the generation of ciphering keys.
11 As [14/15] systems continue to evolve, it became necessary to partition the tasks of
12 authentication and cipher key generation among several commands.

13 The Run CAVE command as shown is used to generate authentication responses and to
14 enable the calculation of ciphering keys upon the invocation of a subsequent command.

15 If ciphering keys are to be generated, the Run CAVE command should carry the input
16 parameter Process_Control with bit 4 set to ON ('1'). Once the authentication response
17 has been delivered via the Get Response command, a cipher key generation command
18 may be issued. This will perform key generation calculations that are based upon the
19 "saved" parameters that were stored upon the execution of the Run CAVE command with
20 bit 4 of the Process_Control octet set to ON.

21 4.4.4.2 Use of Cipher Key Generation Command

22 The command Generate Key/VPM may be invoked at any time following the Run CAVE
23 command with the "save" function ON. One or more instances of Run CAVE may be
24 performed with the "save registers" function OFF during the intervening time period, but
25 the input parameters to the Generate Key/VPM will be those values that were stored
26 upon the most recent invocation of the Run CAVE command with the "save registers"
27 function turned ON. Generate Key/VPM will provide a fixed-length 64-bit key along with a
28 key of host-specified length to the host function upon the execution of the Get Response
29 command.

30

4.4.5 Generate Key/VPM

This command relies on the prior successful execution of the Run CAVE command with the “save” function activated. If this has not occurred, the status word SW='98' and SW='34' shall be returned upon the invocation of this command.

COMMAND	CLASS	INS	P1	P2	Lc	Le
GENERATE KEY/VPM	'A0'	'8E'	'00'	'00'	'02'	*

Command parameters/data:

Octet(s)	Description	Length
1	First octet of VPM to be output	1 byte
2	Last octet of VPM to be output	1 byte

Details value:

Octet(s)		Description of the choice for the VPM to be output.	Length
1	2		
'XX'	'YY'	Retrieve the (YY-XX+1) length of the VPM to be output	(YY-XX+1) bytes
'FF'	'FF'	No VPM to be output	0 byte

Note: If VPM output is present, then the range of 'XX' and 'YY' shall be between '00' and '40'.

Response parameters/data:

Octet(s)	Description	Length
1 – 8	Key	8 bytes
9 –	VPM octets	*

- The number of VPM octets varies as specified by command parameter

4.5 Description of OTASP/OTAPA Commands

4.5.1 MS Key Request

COMMAND	CLASS	INS	P1	P2	Lc	Le
Generate Public Key	'A0'	'50'	'00'	'00'	*	'01'

Command parameters/data:

Octet(s)	Description	Length
1 – 20	RANDSeed	20 bytes
21	A-key Protocol Revision	1 byte
22	Parameter P Length	1 byte
23	Parameter G Length	1 byte
24 – X	Parameter P	Parameter P Length
X+1 to Y	Parameter G	Parameter G Length

*If A-key Protocol Revision is greater than '00000010', Parameter P Length and Parameter G Length shall be set to '00000000' and the Parameter P and G shall be omitted.

Details of command parameters are in [7], section 4.5.1.3, "MS Key Request Message".

Response parameters/data:

Octet(s)	Description	Length
1	Result Code	1 byte

Details of the response are in [7], section 3.5.1.3, "MS Key Response Message".

4.5.2 Key Generation Request

COMMAND	CLASS	INS	P1	P2	Lc	Le
Key Generation Request	'A0'	'52'	'00'	'00'	*	**

Command parameters/data:

Octet(s)	Description	Length
1	BS Result Length	1 byte
2 – Lc	BS Result	Lc – 1 bytes

- Note: Lc=Length of BS Result in octets + 1,

Details of command parameters are in [7], section 4.5.1.4.

Response parameters/data:

Octet(s)	Description	Length
1	Result Code	1 byte
2	MS Result Length	1 byte
3 – Le	MS Result	Le – 2 bytes

1

2 ** Note: Le=Length of MS Result + 2

3 Details of the response are in [7], section 3.5.1.4.

4

4.5.3 Commit

COMMAND	CLASS	INS	P1	P2	Lc	Le
Commit	'A0'	'CC'	'00'	'00'	empty	'01'

Response parameters/data:

Octet(s)	Description	Length
1	Result Code	1 byte

Details of the Commit Request and Response are in [7], sections 4.5.1.6 and 3.5.1.6, respectively.

4.5.4 Validate

COMMAND	CLASS	INS	P1	P2	Lc	Le
Validate	'A0'	'CE'	'00'	'00'	*	'02'

Command parameters/data:

Octet(s)	Description	Length
1	Block ID	1 byte
2	Block Length	1 byte
3 – Lc	Param Data	Lc – 2 bytes

This command requests validation of a single block of data and forms a subset of the “Validation Request Message” as described in [7], section 4.5.1.10.

- Note: Lc = Length of Param Data + 2

Response parameters/data:

Octet(s)	Description	Length
1	Block ID	1 byte
2	Result Code	1 byte

This response pertains to a single block of data and forms a subset of the “Validation Response Message” as described in [7], section 3.5.1.10.

4.5.5 Configuration Request

COMMAND	CLASS	INS	P1	P2	Lc	Le
Configuration Request	'A0'	'54'	'00'	'00'	01	*

Command parameters/data:

Octet(s)	Description	Length
1	Block ID	1 byte

1 This command requests configuration details of a single block of data and forms a subset
2 of the “Configuration Request Message” as described in [7], section 4.5.1.1.

3 Response parameters/data:

Octet(s)	Description	Length
1	Block ID	1 byte
2	Block Length	1 byte
3	Result Code	1 byte
4 – Le	Param Data	Le – 3 bytes

- 4
- 5 • Note: Le = Length of Param Data + 3.

6 This response provides configuration details of a single block of data and forms a subset of
7 the “Configuration Response Message” as described in [7], section 3.5.1.1.

8 4.5.6 Download Request

COMMAND	CLASS	INS	P1	P2	Lc	Le
Download Request	‘A0’	‘56’	‘00’	‘00’	*	‘02’

10

11 Command parameters/data:

Octet(s)	Description	Length
1	Block ID	1 byte
2	Block Length	1 byte
3 – Lc	Param Data	Lc – 2 bytes

12

13 This command requests the download of a single block of data and forms a subset of the
14 “Download Request Message” as described in [7], section 4.5.1.2.

- 15 • Note: Lc = Length of Param Data + 2

16 Response parameters/data:

Octet(s)	Description	Length
1	Block ID	1 byte
2	Result Code	1 byte

17

18 This response pertains to a single block of data and forms a subset of the “Download
19 Response Message” as described in [7], section 3.5.1.2.

20 4.5.7 SSPR Configuration Request

COMMAND	CLASS	INS	P1	P2	Lc	Le
SSPR Configuration Request	‘A0’	‘EA’	‘00’	‘00’	‘04’	*

1 Command parameters/data:

Octet(s)	Description	Length
1	Block ID	1 byte
2 – 3	Request Offset	2 bytes
4	Request Max Size	1 byte

2
3 Note: If Block ID = '0000 0001' (Preferred Roaming List Parameter Block), then octets 2
4 through 4 are used as inputs for this command. For other Block Ids, octets 2 through 4
5 are ignored.

6 Details of command parameters are in [7], section 4.5.1.8, "SSPR Configuration Request
7 Message".

8 Response parameters/data:

Octet(s)	Description	Length
1	Block ID	1 byte
2	Result Code	1 byte
3	Block Length	1 byte
4 – Le	Param Data	Le – 3 bytes

- 9
10 • Note: Le=Length of Param Data + 3.

11 Details of the response are in [7], section 3.5.1.8, "SSPR Configuration Response Message".

12 4.5.8 SSPR Download Request

COMMAND	CLASS	INS	P1	P2	Lc	Le
SSPR Download Request	'A0'	'EC'	'00'	'00'	*	'05'

15 Command parameters/data:

Octet(s)	Description	Length
1	Block ID	1 byte
2	Block Length	1 byte
3 – Lc	Param Data	Lc – 2 bytes

- 17 • Note: Lc=Length of Param Data + 2.

18 Details of the command parameters are in [7], section 4.5.1.9, "SSPR Download Request
19 Message".

20 Response parameters/data:

Octet(s)	Description	Length
1	Block ID	1 byte
2	Result Code	1 byte
3 – 4	Segment Offset	2 bytes
5	Segment Size	1 byte

22 Details of the response are in [7], section 3.5.1.9, "SSPR Download Response Message".

4.5.9 OTAPA Request

COMMAND	CLASS	INS	P1	P2	Lc	Le
OTAPA Request	'A0'	'EE'	'XX'	'00'	'XX'	'06'

P1 is set to '00' if any of the following condition holds:

- ME is assigned with ESN;
- ME is assigned with MEID but service n9 is not allocated or activated;

If service n9 is allocated and activated and ME is assigned with MEID then P1 = '01'

If P1 = '00'

Command parameters/data:

Octet(s)	Description	Length
1	Start/Stop	1 byte
2 - 5	RANDSeed	4 bytes

If P1 = '01'

Command parameters/data:

Octet(s)	Description	Length
1	Start/Stop	1 byte
2 - 5	RANDSeed	4 bytes
6-12	pseudo-ESN	7 bytes

The Start/Stop parameter as defined in Section 4.5.1.11 of [7] shall be coded as follows:

Octet 1

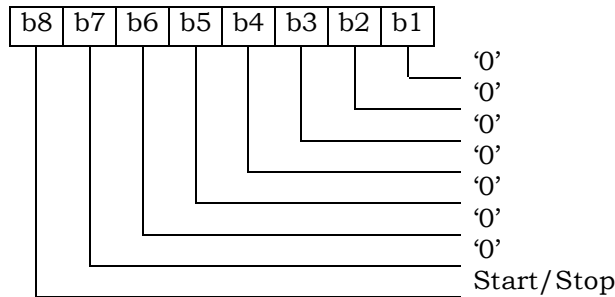

Response parameters/data:

Octet(s)	Description	Length
1	Result Code	1 byte
2	NAM_LOCK Indicator	1 byte
3 - 6	RAND OTAPA	4 bytes

* The RAND_OTAPA (bytes 3-6) is returned if and only if the Result_Code is '00' and the NAM_LOCK_STATE is enabled (= '1').

1 The NAM_LOCK Indicator parameter as defined in Section 3.5.1.11 of [7] shall be coded as
 2 follows:

3 Octet 2

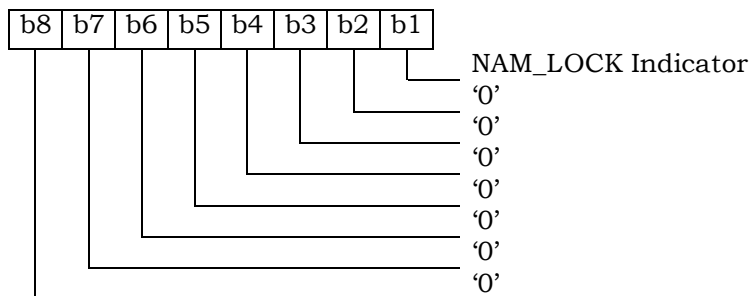

4
 5 Details of the response are in [7], section 3.5.1.11, “OTAPA Response Message”.

6 4.5.10 PUZL Configuration Request

7

COMMAND	CLASS	INS	P1	P2	Lc	Le
PUZL Configuration Request	'A0'	'F4'	'00'	'00'	*	*

8
 9 Command parameters/data:

Octet(s)	Description	Length
1	Block ID ('0000 0000')	1 byte

10
 11 Note: If Block ID = '0000 0001' (PUZL Priorities Parameter Block), then octets 2 through 4
 12 are used as inputs for this command.

13

Octet(s)	Description	Length
1	Block ID ('0000 0001')	1 byte
2 – 3	Request Index	2 bytes
4	Request Max Entries	1 byte

14 The Request Index parameter as defined in [7] shall be coded as follows:

15 Octet 2

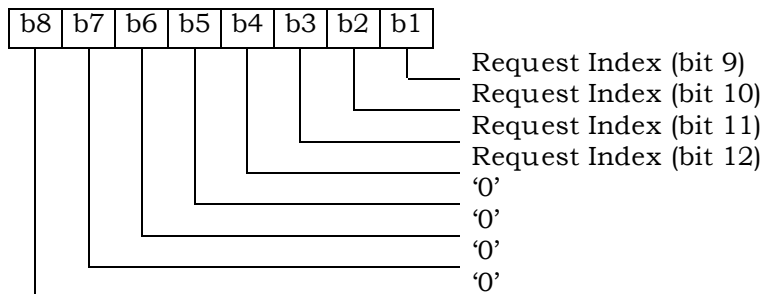

16 Octet 3

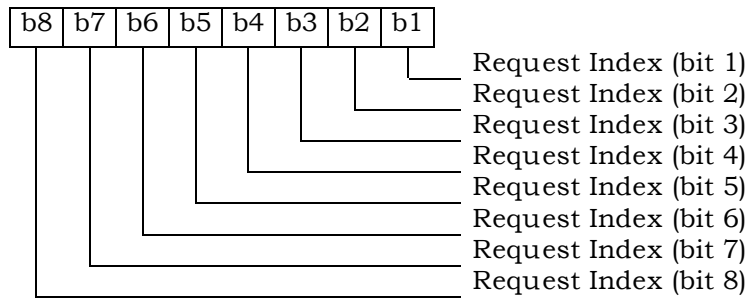

1

2 Note: If Block ID = '0000 0010' (User Zone Parameter Block), then octets 2 through 8 are
 3 used as inputs for this command.

4

Octet(s)	Description	Length
1	Block ID ('0000 0010')	1 byte
2 - 3	UZ_ID	2 bytes
4 - 5	UZ_SID	2 bytes
6 - 7	Request Offset	2 bytes
8	Request Max Size	1 byte

5 The UZ_SID parameter as defined in [7] shall be coded as follows:

6 Octet 4

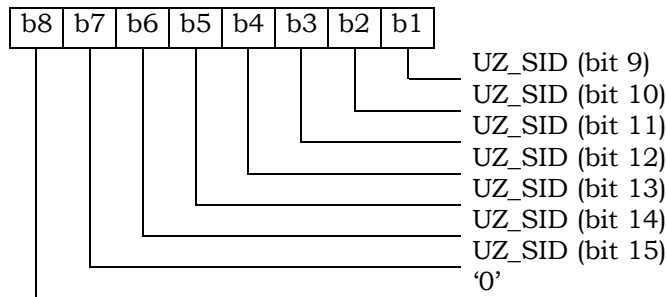

7 Octet 5

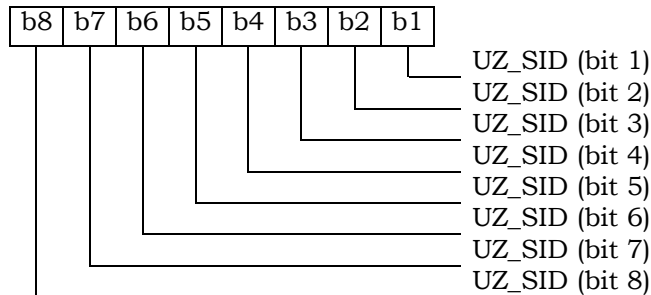

8

9 The Request Offset parameter as defined in [7] shall be coded as follows:

10 Octet 6

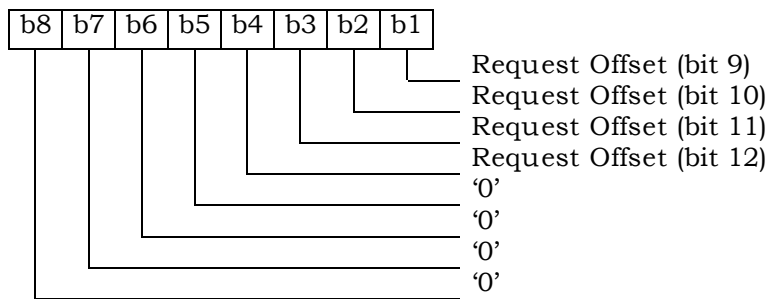

1 Octet 7

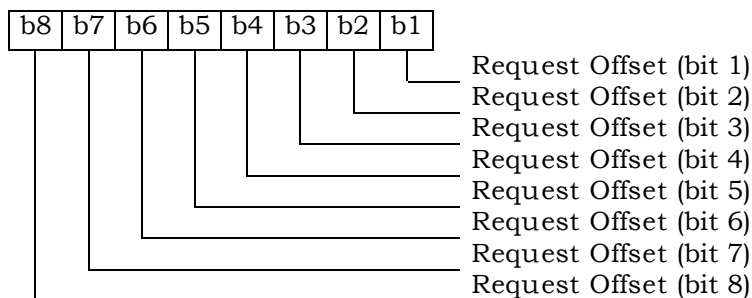

2

3 Note: If Block ID = '0000 0011' (Preferred User Zone List Parameter Block), then octets 2
4 through 4 are used as inputs for this command.

5

Octet(s)	Description	Length
1	Block ID ('0000 0011')	1 byte
2 - 3	Request Index	2 bytes
4 - 5	Request Offset	2 bytes
6	Request Max Size	1 byte

6 Details of command parameters are in [7], section 4.5.1.12, "PUZL Configuration Request
7 Message".

8 Response parameters/data:

Octet(s)	Description	Length
1	Block ID	1 byte
2	Result Code	1 byte
3	Block Length	1 byte
4 - Le	Param Data	Le - 3 bytes

9

10 * Note: Le=Length of Param Data + 3.

11 Details of the response are in [7], section 3.5.1.12, "PUZL Configuration Response
12 Message".

13 4.5.11 PUZL Download Request

14

COMMAND	CLASS	INS	P1	P2	Lc	Le
PUZL Download Request	'A0'	'F6'	'00'	'00'	*	'05'

15

1 Command parameters/data:

Octet(s)	Description	Length
1	Block ID	1 byte
2	Block Length	1 byte
3 - Lc	Param Data	Lc - 2 bytes

2

3 * Note: Lc=Length of Param Data + 2.

4 Details of the command parameters are in [7], section 4.5.1.13, "PUZL Download Request
5 Message".

6 Response parameters/data:

Octet(s)	Description	Length
1	Block ID	1 byte
2	Result Code	1 byte
3	Identifiers Present Flag	1 byte
4 - 5	UZ_ID	2 bytes
6 - 7	UZ_SID	2 bytes

7

8 The Identifiers Present Flag parameter as defined in [7] shall be coded as follows:

9 Octet 3

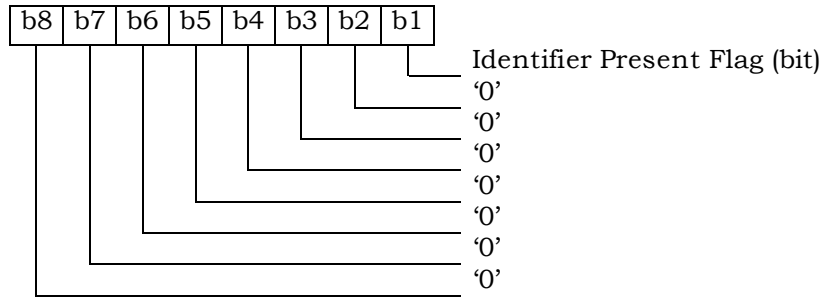

10

11 * The bytes 4-7 are returned if the Identifiers Present Flag is set to '1'.

12 Details of the response are in [7], section 3.5.1.13, "PUZL Download Response Message".

13 The UZ_SID parameter as defined in [7] shall be coded as follows:

14 Octet 6

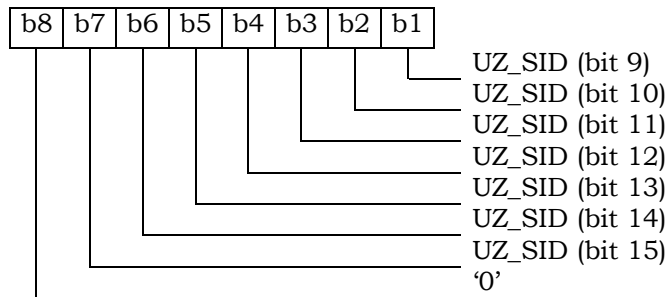

15 Octet 7

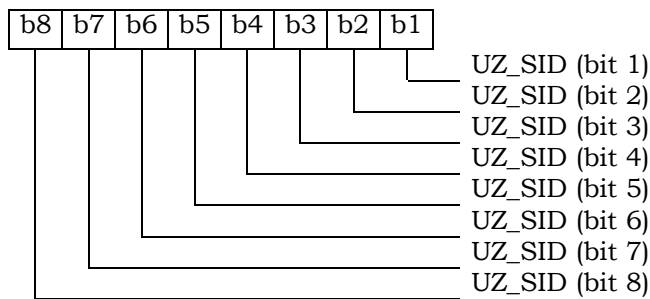

1

4.5.12 3GPD Configuration Request

2

3

COMMAND	CLASS	INS	P1	P2	Lc	Le
3GPD Configuration Request	'A0'	'FC'	'00'	'00'	01	*

4

Command parameters/data:

5

Octet(s)	Description	Length
1	Block ID	1 byte

6

This command requests 3GPD configuration details of a single block of data and forms a subset of the “3GPD Configuration Request Message” as described in [7], section 4.5.1.15.

7

8

Response parameters/data:

9

Octet(s)	Description	Length
1	Block ID	1 byte
2	Block Length	1 byte
3	Result Code	1 byte
4 – Le	Param Data	Le – 3 bytes

10

* Note: Le = Length of Param Data + 3.

11

This response provides 3GPD configuration details of a single block of data and forms a subset of the “3GPD Configuration Response Message” as described in [7], section 3.5.1.14.

12

13

4.5.13 3GPD Download Request

14

15

COMMAND	CLASS	INS	P1	P2	Lc	Le
3GPD Download Request	'A0'	'48'	'00'	'00'	*	'02'

16

1 Command parameters/data:

Octet(s)	Description	Length
1	Block ID	1 byte
2	Block Length	1 byte
3 – Lc	Param Data	Lc – 2 bytes

2
3 This command requests the 3GPD download of a single block of data and forms a subset of
4 the “3GPD Download Request Message” as described in [7], section 4.5.1.15.

5 * Note: Lc = Length of Param Data + 2.

6 Response parameters/data:

Octet(s)	Description	Length
1	Block ID	1 byte
2	Result Code	1 byte

7
8 This response pertains to a single block of data and forms a subset of the “3GPD
9 Download Response Message” as described in [7], section 3.5.1.15.

10 4.5.14 Secure Mode

COMMAND	CLASS	INS	P1	P2	Lc	Le
Secure Mode	‘A0’	‘4A’	‘00’: start ‘01’: stop	‘See below’	‘08’ empty	‘01’

11
12
13 P1=‘00’

14 Command parameters/data:

Octet(s)	Description	Length
1 – 8	RAND_SM	8 bytes

15 Details of command parameters are in [7], section 4.5.1.16, “Secure Mode Request
16 Message”.

17 Response parameters/data:

Octet(s)	Description	Length
1	Result Code	1 byte

18 Details of response parameters are in [7], section 3.5.1.16, “Secure Mode Response
19 Message”.

20 P1=‘01’

21 Command parameters/data:

22 No command parameters are generated.

23 P2 shall be used for "KEY_IN_USE" parameter as described in [7].

24 If KEY_IN_USE = '0000', then P2 = 0x00

25 If KEY_IN_USE = '0001', then P2 = 0x01.

1

2 Response parameters/data:

Octet(s)	Description	Length
1	Result Code	1 byte

3 Details of response parameters are in [7], section 3.5.1.16, "Secure Mode Response
4 Message".

5 4.5.15 FRESH

6

COMMAND	CLASS	INS	P1	P2	Lc	Le
FRESH	'A0'	'4C'	'00': put '01': get	'00'	'02' empty	Empty '02'

7

8 P1='00'

9 Command parameters/data:

Octet(s)	Description	Length
1 - 2	Crypto-Sync	2 bytes

10 Response parameters/data:

11

12 No response parameters are generated as a result of command execution. Successful
13 generation will cause SW1 to be set to '90' and SW2 to be set to '00'. Unsuccessful
14 generation will cause SW1 to be set to '98' and SW2 to be set to '04'.

15 P1='01'

16 Command parameters/data:

17 No command parameters are generated.

18 Response parameters/data:

Octet(s)	Description	Length
1 - 2	Crypto-Sync	2 bytes

19 The Crypto-Sync parameter as defined in [7] shall be coded as follows:

20 Octet 1

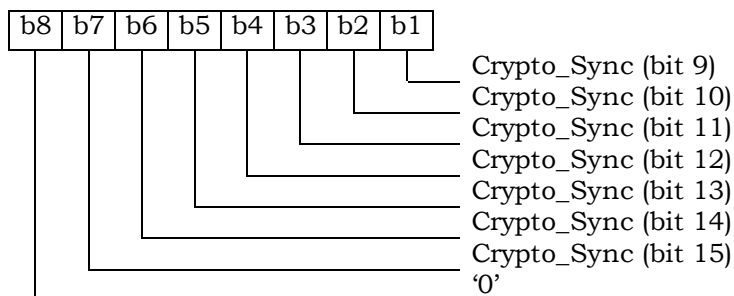

21 Octet 2

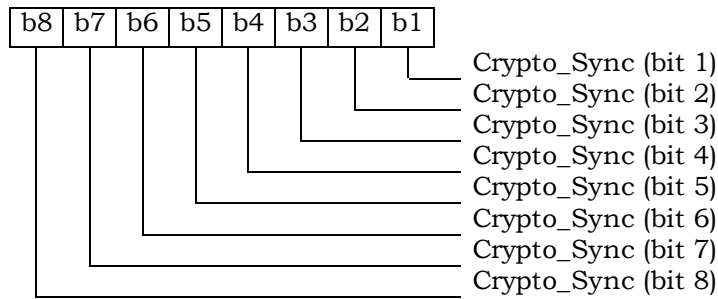

1

4.5.16 Service Key Generation Request

2

3

COMMAND	CLASS	INS	P1	P2	Lc	Le
Service Key Generation Request	'A0'	'4E'	'00'	'00'	'02'	'01'

4

Command parameters/data:

5

Octet(s)	Description	Length
1-2	KEY_ID	2 bytes

6

The bitmap of KEY_ID defined in Table 4.5.1.22-1 of [7] shall be coded as follows:

7

8

9

Byte 1:

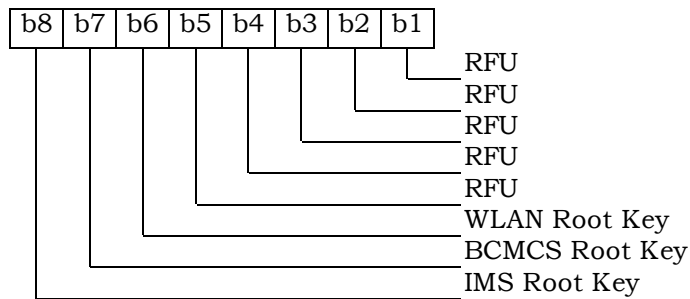

10

11

Byte 2:

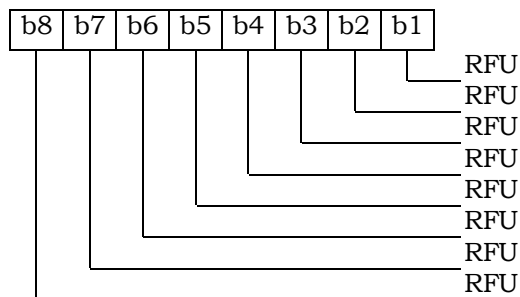

12

Response parameters/data:

13

Octet(s)	Description	Length
1	Result Code	1 byte

Details of response parameters are in [7].

4.5.17 MMD Configuration Request

COMMAND	CLASS	INS	P1	P2	Lc	Le
MMD Configuration Request	'A0'	'C4'	'00'	'00'	'01'	*

Command parameters/data:

Octet(s)	Description	Length
1	Block ID	1 byte

This command requests configuration details of a single block of data and forms a subset of the "MMD Configuration Request Message" as described in [7], section 4.5.1.18.

Response parameters/data:

Octet(s)	Description	Length
1	Block ID	1 byte
2	Block Length Result Code	1 byte
3	Block Length Result Code	1 byte
4 – Le	Param Data	Le – 3 bytes

* Note: Le=Length of Param Data + 3.

Details of the response are in [7], section 3.5.1.18, "MMD Configuration Response Message".

4.5.18 MMD Download Request

COMMAND	CLASS	INS	P1	P2	Lc	Le
MMD Download Request	'A0'	'C6'	'00'	'00'	*	'02'

Command parameters/data:

Octet(s)	Description	Length
1	Block ID	1 byte
2	Block Length	1 byte
3 – Lc	Param Data	Lc – 2 bytes

* Note: Lc=Length of Param Data + 2.

Details of the command parameters are in [7], section 4.5.1.19, "MMD Download Request Message".

1 Response parameters/data:

Octet(s)	Description	Length
1	Block ID	1 byte
2	Result Code	1 byte

2
3 Details of the response are in [7], section 3.5.1.19, “MMD Download Response Message”.

4 4.5.19 MMS Configuration Request

COMMAND	CLASS	INS	P1	P2	Lc	Le
MMS Configuration Request	‘A0’	‘42’	‘00’	‘00’	‘01’	*

6
7 Command parameters/data:

Octet(s)	Description	Length
1	Block ID	1 byte

8
9 This command requests configuration details of a single block of data and forms a subset
10 of the “MMS Configuration Request Message” as described in [7], section 4.5.1.23.

11 Response parameters/data:

Octet(s)	Description	Length
1	Block ID	1 byte
2	<i>Block Length Result Code</i>	1 byte
3	<i>Block Length Result Code</i>	1 byte
4 – Le	Param Data	Le – 3 bytes

12
13 * Note: Le=Length of Param Data + 3.

14 Details of the response are in [7], section 3.5.1.23, “MMS Configuration Response
15 Message”.

16 4.5.20 MMS Download Request

COMMAND	CLASS	INS	P1	P2	Lc	Le
MMS Download Request	‘A0’	‘46’	‘00’	‘00’	*	‘02’

17
18
19 Command parameters/data:

Octet(s)	Description	Length
1	Block ID	1 byte
2	Block Length	1 byte
3 – Lc	Param Data	Lc – 2 bytes

20
21 * Note: Lc=Length of Param Data + 2.

1 Details of the command parameters are in [7], section 4.5.1.24, “MMS Download Request
2 Message”.

3 Response parameters/data:

Octet(s)	Description	Length
1	Block ID	1 byte
2	Result Code	1 byte

4
5 Details of the response are in [7], section 3.5.1.24, “MMS Download Response Message”.

6 4.5.21 System Tag Configuration Request

COMMAND	CLASS	INS	P1	P2	Lc	Le
System Tag Configuration Request	'A0'	'C8'	'00'	'00'	'04'	*

7
8
9 Command parameters/data:

Octet(s)	Description	Length
1	Block ID	1 byte
2 – 3	Request Offset	2 bytes
4	Request Max Size	1 byte

10
11 Note:

12 If Block ID = '0000 0010' (Group Tag List), '0000 0100' (Specific Tag List), or '0000 0110' (Call
13 Prompt List), then octets 2 through 4 are used as inputs for this command. For other
14 Block IDs, octets 2 through 4 are ignored.

15 Details of command parameters are in [7], section 4.5.1.20, “System Tag Configuration
16 Request Message”.

17 Response parameters/data:

Octet(s)	Description	Length
1	Block ID	1 byte
2	Result Code	1 byte
3	Block Length	1 byte
4 – Le	Param Data	Le - 3 bytes

18
19 * Note: Le=Length of Param Data + 3.

20 Details of the response are in [7], section 3.5.1.20, “System Tag Configuration Response
21 Message”.

22 4.5.22 System Tag Download Request

23

COMMAND	CLASS	INS	P1	P2	Lc	Le
System Tag Download Request	'A0'	'CA'	'00'	'00'	*	'05'

1

2 Command parameters/data:

Octet(s)	Description	Length
1	Block ID	1 byte
2	Block Length	1 byte
3 – Lc	Param Data	Lc - 2 bytes

3

4 * Note: Lc=Length of Param Data + 2.

5 Details of the command parameters are in [7], section 4.5.1.21, “System Tag Download
6 Request Message”.

7 Response parameters/data:

Octet(s)	Description	Length
1	Block ID	1 byte
2	Result Code	1 byte
3 – 4	Segment Offset	2 bytes
5	Segment Size	1 byte

8

9 Note: If the BLOCK_ID = '0000 0001' (Group Tag List), '0000 0010' (Specific Tag List), or
10 '0000 0011' (Call Prompt List), then octets 3 through 5 are used. For other Block IDs, octets
11 3 through 5 are ignored.12 Details of the response are in [7], section 3.5.1.21, “System Tag Download Response
13 Message”.

14

15

4.6 ESN and MEID Management Command

If T=0 protocol is used, APDU is mapped onto TPDU. (See Section 9.1 in [17])

4.6.1 Store ESN_MEID_ME

COMMAND	CLASS	INS	P1	P2	Lc	Le
Store ESN_MEID_ME	'A0'	'DE'	'XX'	'00'	'08'	'01'

P1 is set to '00' if any of the following condition holds:

- ME is assigned with ESN;
- ME is assigned with MEID but service n9 is not allocated or activated;

If service n9 is allocated and activated and ME is assigned with MEID then P1 = '01'

Command parameters/data: (P1 = '00'):

Octet(s)	Description	Length
1	ESN_ME Length	1 byte
2 – 8	ESN_ME	7 bytes

ESN is encoded with the lowest-order byte first to match the coding for EF_{ESN-ME}.

During the ME and R-UIM initialization process, the ME shall invoke the “Store ESN_MEID_ME” command to store its ESN in EF '6F38'. The ESN_ME length, expressed in octets, is specified by bits 0 through 3, inclusive, of Octet 1, where bit 3 is MSB and bit 0 is LSB.

Bits 4 thru 7 of Octet 1 are RFU.

Response parameters/data:

Octet(s)	Description	Length
1	Change Flag, Usage Indicator	1 byte

Bit 0 (LSB) of Octet 1 indicates whether the ESN_ME is different from the previous ESN or MEID that was stored in EF '6F38'. Bit 0 is set to '0' if the ESN_ME has not changed and is set to '1' if it has changed. This allows the ME to re-register as required in Section 5.1.1.

Bits 1 through 3 are RFU and are set to '000'.

Bit 4 of Octet 1 form a “Usage Indicator”, as defined in EF 6F42. Bit 4 indicates whether the 32 LSBs of the UIM_ID or the 32 LSBs of the handset ESN are used as the “ESN” input to calculations performed using CAVE. If bit 4 is set to '1', UIM_ID is used for both identification and for authentication calculations; i.e. UIM_ID is used instead of ESN in every place where ESN is used in [5] and [14]. If bit 4 is set to '0', the handset ESN is used for both identification and for authentication calculations.

Bits 5 through 7 of Octet 1 are RFU and are set to '00'.

1 If an R-UIM which does not support service n9 is inserted into a ME assigned with MEID,
 2 the ME shall issue the Store ESN_MEID_ME (P1= 00) command with Pseudo-ESN value in
 3 the ESN field.

5 Command parameters/data: (P1 = '01'): used by ME (assigned with MEID)

Octet(s)	Description	Length
1	MEID Length	1 byte
2 – 8	MEID	7 bytes

8 During the ME and R-UIM initialization process, the ME shall invoke the “Store
 9 ESN_MEID_ME” command to store its MEID in EF_{ESN_ME} '6F38'. The MEID length, expressed
 10 in octets, is specified by bits 0 through 3, inclusive, of Octet 1, where bit 3 is MSB and bit 0
 11 is LSB.

12 Bits 4 through 7 of Octet 1 are RFU.

14 Response parameters/data:

Octet(s)	Description	Length
1	Change Flag, Usage Indicator	1 byte

16 Bit 0 (LSB) of Octet 1 indicates whether the MEID is different from the previous ESN or
 17 MEID that was stored in EF_{ESN_ME} '6F38'. Bit 0 is set to '0' if the MEID has not changed and
 18 is set to '1' if it has changed. This allows the ME to re-register as required in Section 5.1.1.

19 Bits 1 through 3 are RFU and are set to '000'.

20 Bit 4 of Octet 1 forms a “Usage Indicator”, as defined in EF_{USGIND} '6F42'. Bit 4 indicates
 21 whether the 32 LSBs of the UIM_ID or the 32 LSBs of the handset Pseudo-ESN are used as
 22 the “ESN” input to calculations performed using CAVE. If bit 4 is set to '1', UIM_ID is used
 23 for both identification and for authentication calculations; i.e. UIM_ID is used instead of
 24 pseudo ESN in every place where ESN is used in [5] and [14]. If bit 4 is set to '0', the
 25 handset Pseudo-ESN is used for both identification and for authentication calculations.

26 Bit 5 indicates whether the 56 bits of the SF_EUIMID (stored in EF_{SF_EUIMID}) or the 56 bits of
 27 the handset MEID is used in every place where MEID is used in [5]. If bit 5 is set to '1', then
 28 the SF_EUIMID is used. If bit 5 is set to '0', then the handset MEID is used. If service n8 is
 29 not allocated, b5 value shall not be interpreted by the handset.

30 Bits 6 through 7 of Octet 1 are RFU and are set to '00'.

4.7 Description of Packet Data Security-Related Functions

This section describes the interface between the ME and R-UIM when the R-UIM performs service authentication and access authentication functions for 3G packet data service. Currently [23] defines Simple IP and Mobile IP as the two access methods for service authentication. Simple IP refers to a service in which an access provider network assigns an IP address and supplies an IP routing address to a mobile station (MS). When using Simple IP, the network may request either Point-to-Point Challenge Handshake Authentication Protocol (PPP CHAP) or Point-to-Point Password Authentication Protocol (PPP PAP) to authenticate the user. Mobile IP refers to a service where the network provides the user with IP routing service to a public IP network and/or secure IP routing service to private networks. When using Mobile IP, the network authenticates the user by Mobile IP mobile-home authentication and Mobile IP challenge/response authentication.

[29] defines access authentication used for HRPD. Access authentication is a procedure in which the Access Terminal (AT) is authenticated by the AN-AAA (Access Network Authentication, Authorization and Accounting entity).

Figure 4.7-1 shows the authentication model for both the packet data service and voice services.

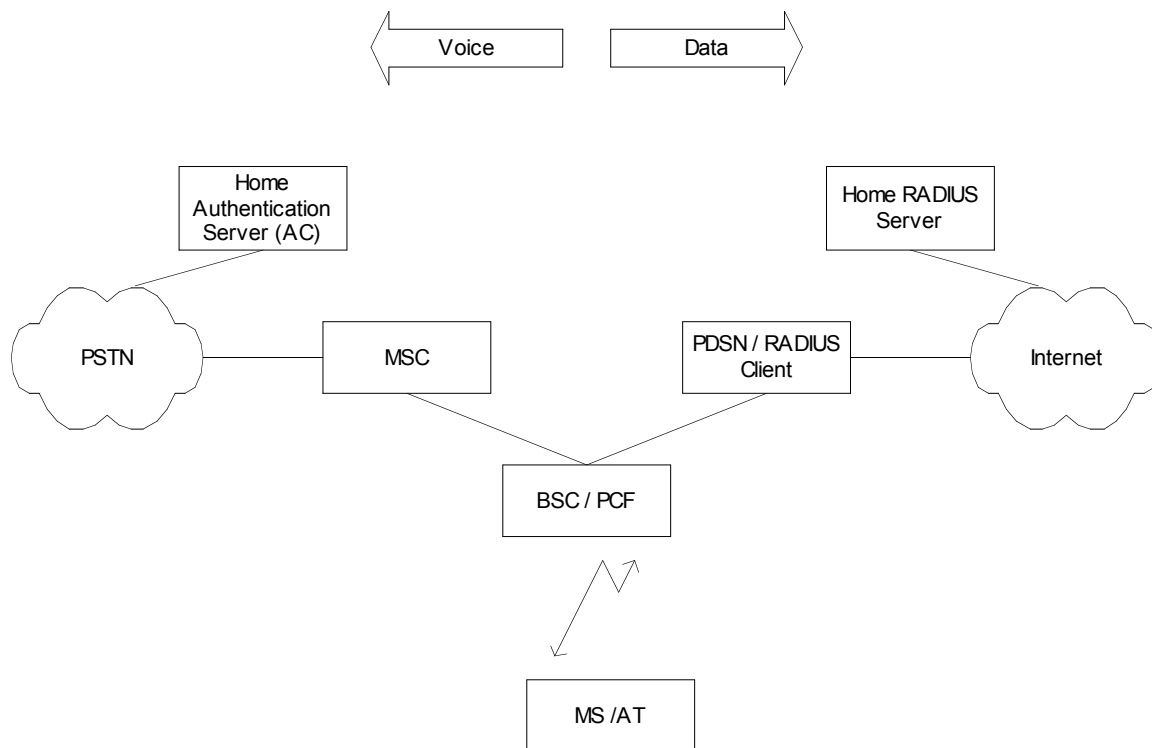

Figure 4.7-1. Authentication Models

4.7.1 Managing Shared Secrets

The R-UIM stores and manages the Shared Secrets (SS) used in Simple IP and Mobile IP operation for packet data authentication calculations. The network can update the Shared Secrets on the R-UIM using secure mode OTASP/OTAPA messages.

4.7.2 Performing Simple IP Authentication

To start the Simple IP authentication process, the network (PDSN) sends a CHAP-Challenge to the mobile station along with the same CHAP-ID sent by the mobile station in the access request. The mobile equipment (ME) will forward this information to the R-UIM with the NAI-Entry-Index used in the access request using the Compute IP authentication command (option CHAP). This NAI-Entry-Index determines the SS to be used in the calculation of the CHAP-Response. The R-UIM computes the CHAP-Response and passes it to the ME to be subsequently forwarded to the network. If the CHAP-Response sent by the MS matches the network's calculated CHAP-Response, the network will send back an Access-Accept granting service.

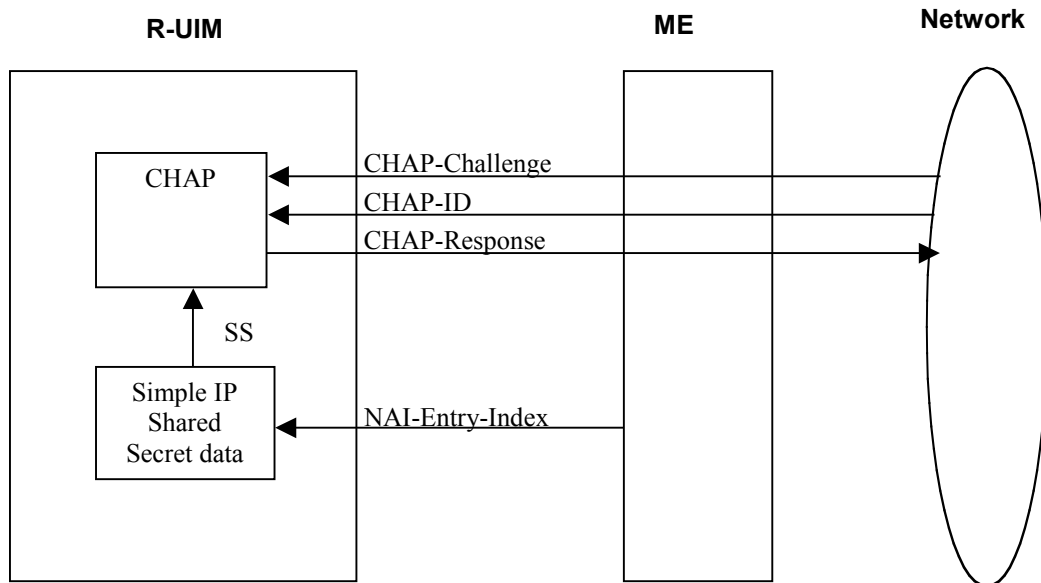

Figure 4.7.2-1. Compute IP Authentication Command (CHAP Option)

4.7.3 Performing Mobile IP Authentication

For a mobile station that uses Mobile IP, the PDSN shall begin transmission of an operator configurable number of Agent Advertisements immediately following establishment of PPP or upon reception of an Agent Solicitation message from the mobile station. Mobile IP authentication takes place after the mobile receives the agent advertisement message with a challenge from the host. To authenticate, the mobile station shall start by sending a Mobile IP registration request message (MIP-RRQ) to the network as defined in [23]. This

1 message shall include various extensions that allow authentication data to be carried
2 from the mobile station to the PDSN. The PDSN then sends the authentication data to a
3 RADIUS server by use of an Access Request message. Once the Authentication is
4 successful, the RADIUS server responds either with an Access Accept message to grant
5 service or with an Access Reject to refuse service.

6 The MIP_RRQ message shall include the following extensions as specified in [23] in the
7 order given:

- 8 1. MN-NAI Extension [25]
- 9 2. MN-HA Authentication Extension [24]
- 10 3. MN-FA Challenge Extension [27]
- 11 4. MN-AAA Extension [27]

12 The mobile station shall use a static Home Agent (HA) address.

13 To calculate the MN-HA Authentication extension, the ME sends the Compute IP
14 authentication command (MN-HA Authenticator option) to the R-UIM with the following
15 information:

- 16 - the NAI-Entry-Index to indicate the NAI used in the request,
- 17 - the protected fields of the MIP-RRQ (Registration Message) (refer to [24]).

18 The protected fields are:

- 19 - the UDP payload,
- 20 - all prior Extensions in their entirety and
- 21 - the Type, Length and SPI of this Extension.

22 The R-UIM returns the MN-HA-Authenticator by hashing the MN-HA Shared Secret
23 indicated by the associated NAI with the protected fields in the registration message.

24 Since the RADIUS protocol defined in [26] can not carry attributes greater than 253 in
25 size, the preceding Mobile IP data, type, subtype (if present), length and SPI are hashed
26 before the MN-AAA Authenticator can be generated. This is achieved by using the
27 Compute IP authentication command (MIP-RRQ Hash option). In this command the ME
28 sends the preceding MIP-RRQ data to the R-UIM and the R-UIM calculates the Hash of this
29 data. The Hash is not returned to the ME.

30 Subsequently, this MIP-RRQ Hash, the CHALLENGE from the network and the NAI-Entry-
31 Index identifying the secret the mobile station shares with the home RADIUS server shall
32 be sent to the R-UIM in the Compute IP authentication command (MN-AAA Authenticator
33 option).

34 The R-UIM computes the MN-AAA Authenticator according to [27], and returns to the ME,
35 to be sent in the MIP-RRQ message to the network.

36

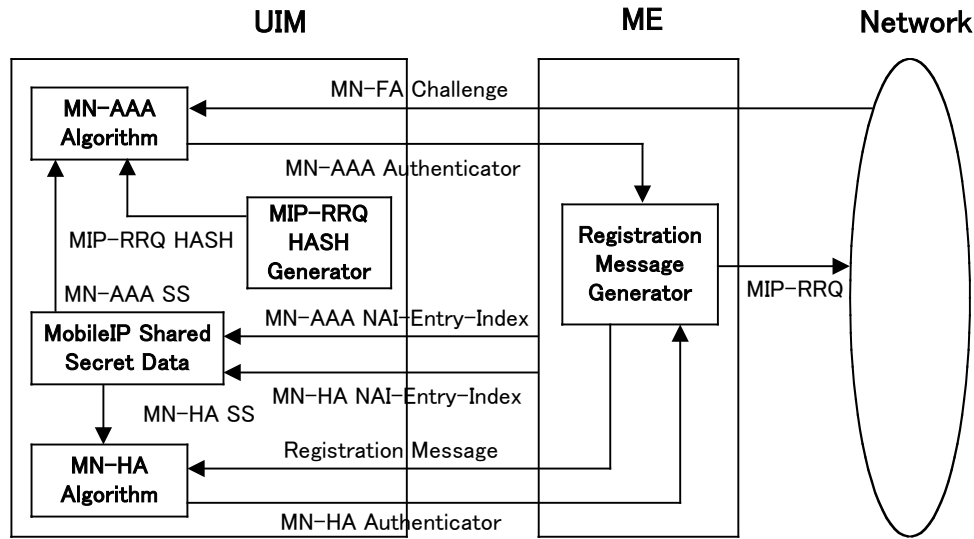

Figure 4.7.3-1. Computation of MN-AAA Authenticator

4.7.4 HRPD Access Authentication

For access authentication, the AT and the network AN initiate Point-to-Point Protocol (PPP) and Link Control Protocol (LCP) negotiations. If the access authentication feature is used, the AN always proposes CHAP as a PPP option in an initial LCP Configure-Request during the PPP establishment. The AN generates a random challenge and sends it to the AT in a CHAP-Challenge message.

The mobile equipment (ME) will forward this information to the R-UIM using the Compute IP authentication command (option HRPD Access Authentication). The R-UIM computes the CHAP-Response and passes it to the ME to be subsequently forwarded to the network. If the CHAP-Response sent by the AT matches the network's calculated CHAP-Response, the AN will return an indication of CHAP access authentication success to the AT.

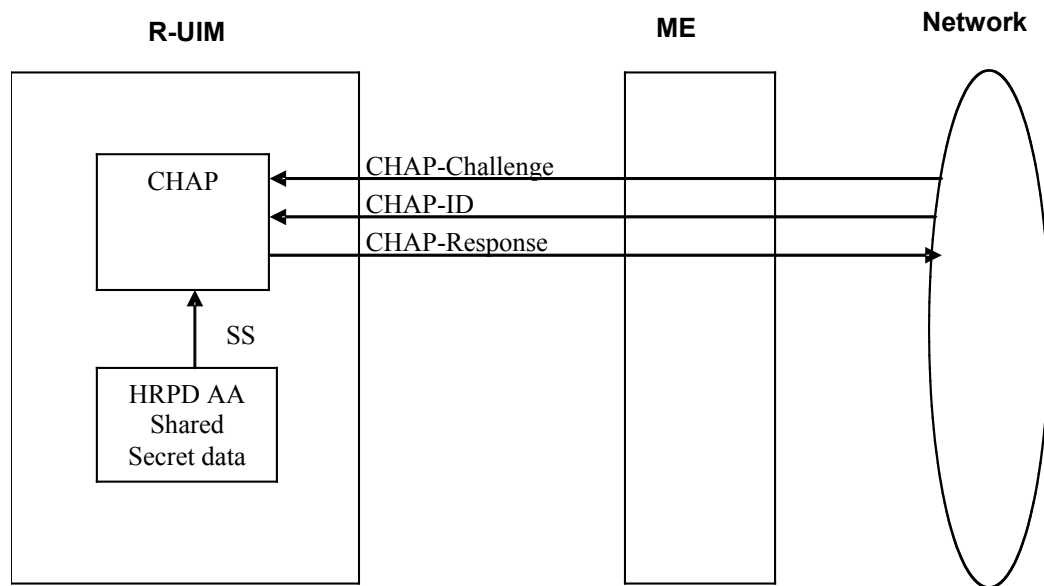

Figure 4.7.4-1. HRPD Access Authentication Command

4.8 Description of Packet Data Security-Related Commands

4.8.1 Compute IP Authentication

This command computes responses and authenticators for use in Simple IP, Mobile IP and HRPD Access Authentication.

COMMAND	CLASS	INS	P1	P2	Lc	Le
Compute IP Authentication	'80'	'80'	P1	P2	Lc	Le

P1 parameter defines the IP authentication command type:

P1	CLASS
00	CHAP
01	MN-HA Authenticator
02	MIP-RRQ Hash
03	MN-AAA Authenticator
04	HRPD Access Authenticator

The mobile must perform the MN-HA Authenticator, MIP-RRQ Hash and MN-AAA Authenticator types in sequence. If either MIP-RRQ Hash or MN-AAA Authenticator are run out of sequence, the R-UIM shall return SW1='98' and SW2='34'. However, the mobile can execute the MN-HA Authenticator any number of times before the MIP-RRQ Hash and MN-AAA authenticator command.

4.8.1.1 CHAP

This IP authentication command type generates the CHAP response.

COMMAND	CLASS	INS	P1	P2	Lc	Le
Compute IP Authentication	'80'	'80'	'00'	'00'	*	'10'

Command parameters/data:

Octet(s)	Description	Length
1	CHAP_ID	1 byte
2	NAI-Entry-Index	1 byte
3 - X	CHAP-Challenge	Lc - 2 byte

CHAP-ID: CHAP Identifier as specified in [23] and [26].

NAI-Entry-Index: The Simple IP NAI-Entry-Index indicates the Shared Secret to use from the Simple IP CHAP SS Parameters block.

CHAP-Challenge: Challenge received from the network used in computing the CHAP-Response. The length of the CHAP-Challenge depends upon the method used to generate the octets, and is independent of the hash algorithm used.

*Lc = Length of CHAP-Challenge + 2.

Response parameters/data:

Octet(s)	Description	Length
1 - 16	CHAP-Response	16 bytes

The R-UIM calculates the CHAP-Response as follows:

CHAP-Response = Algo (CHAP-ID || CHAP-SS || CHAP-Challenge)

CHAP-SS: Simple IP CHAP Shared Secret associated with the given NAI-Entry-Index

Algo: The operator shall choose the function for one-way hashing. MD5 is defined as the hashing function, but the operator may choose another hashing function.

4.8.1.2 MN-HA Authenticator

This IP authentication command type computes the MN-HA Authenticator. If the maximum length of the Registration-Message exceeds 254 bytes, this command shall chain successive blocks of registration data with a maximum size of 254 bytes each. If the blocks used within the command are run out of sequence, the card shall return SW1='98' and SW2='34'.

COMMAND	CLASS	INS	P1	P2	Lc	Le
Compute IP Authentication	'80'	'80'	'01'	*	*	*

P2 contains chaining information as follows:

P2	Block
'00'	First Block
'01'	Next Block
'02'	Single Block
'03'	Last Block

*Le : 0 bytes for P2 = '00' or '01'

16 bytes for P2 = '02' or '03'

The command data depends on the value of P2:

P2 = '00' or '02':

Command parameters/data:

Octet(s)	Description	Length
1	NAI-Entry-Index	1 byte
2 - X	Registration-Data	Lc - 1 bytes

P2 = '01' or '03':

Command parameters/data:

Octet(s)	Description	Length
1 - X	Registration-Data	Lc bytes

NAI-Entry-Index: The Mobile IP NAI-Entry-Index indicates the MN-HA Shared Secret to use from the Mobile IP SS Parameters block.

Registration-Data: Protected fields from the registration message pursuant to [24]. The protected fields contain the UDP payload, all prior Extensions in their entirety and the Type, Length and SPI of this Extension (See Section 4.7.3). Maximum length of the Registration-Data is 254 octets per block.

The response depends on the chaining information P2:

P2 = '00' or '01'

Response: NONE

P2 = '02' or '03'

Response parameters/data:

Octet(s)	Description	Length
1 - 16	MN-HA Authenticator	16 bytes

The R-UIM calculates the MN-HA Authenticator response as follows:

MN-HA Authenticator = Algo (MN-HA SS || Registration-Message || MN-HA SS)

MN-HA SS: MN-HA Shared Secret associated with the given NAI-Entry-Index.

Registration-Message: The complete Registration-Message containing the Registration-Data blocks in the consecutive command messages.

1 Algo: The operator shall choose the function for one-way hashing. MD5 is defined as the
2 hashing function, but the operator may choose another hashing function.

3 4.8.1.3 MIP-RRQ Hash

4 This IP authentication command type calculates the MIP-RRQ Hash. As the preceding
5 MIP-RRQ data can exceed 247 bytes, it shall be sent to the R-UIM in one or several
6 successive blocks, depending on its actual length. If the command blocks are run out of
7 sequence, the card shall return SW1='98' and SW2='34'.

COMMAND	CLASS	INS	P1	P2	Lc	Le
Compute IP Authentication	'80'	'80'	'02'	*	*	'00'

8 P2 contains chaining information as follows:

P2	Block
'00'	First Block
'01'	Next Block
'02'	Single Block
'03'	Last Block

10 The command data depends on the value of P2:

11 P2 = '00' or '01':

12 Command parameters/data:

Octet(s)	Description	Length
1 - X	Preceding MIP-RRQ Data	Lc bytes

13 P2 = '02' or '03':

14 Command parameters/data:

Octet(s)	Description	Length
1 - X	Preceding MIP-RRQ Data	Lc - 8 bytes
X+1 - X+8	MN-AAA Extension Header	8 bytes

15 MN-AAA Extension Header: Type, Length and SPI fields of the MN-AAA EXTENSION.

16 Preceding MIP-RRQ Data: The mobile IP registration request preceding the MN-AAA
17 EXTENSION. Maximum length of the Preceding MIP-RRQ Data is 255 for the first and next
18 blocks and 247 octets for the last or single blocks.

19 Response parameters/data:

20 NONE

21 The R-UIM will calculate the MIP-RRQ Hash as follows:

22 MIP-RRQ Hash: Algo (PRECEDING-MIP-RRQ || MN-AAA Extension Header)

PRECEDING-MIP-RRQ: The complete preceding mobile IP registration request, containing the Preceding MIP-RRQ Data from the consecutive MIP-RRQ Hash options.

Algo: The operator shall choose the function for one-way hashing. MD5 is defined as the hashing function, but the operator may choose another hashing function.

4.8.1.4 MN-AAA Authenticator

This IP command type computes the MN-AAA Authenticator.

COMMAND	CLASS	INS	P1	P2	Lc	Le
Compute IP Authentication	'80'	'80'	'03'	'00'	*	'10'

Command parameters/data:

Octet(s)	Description	Length
1	NAI-Entry-Index	1 byte
2 - X	Challenge	Lc-1 bytes

NAI-Entry-Index: The Mobile IP NAI-Entry-Index indicates the MN-AAA Shared Secret to be used from the Mobile IP SS Parameters block.

Challenge: Challenge in the MN-AAA Extension. If the ME receives a challenge greater than 237 bytes, it will send the highest-order byte and least significant 237 bytes to the R-UIM. If the challenge has fewer than 238 bytes, this R-UIM shall include the high-order byte in the computation twice, but ensures that the challenge is used exactly as is. Additional padding is never used to increase the length of the challenge.

*Lc = Length of Challenge + 1 bytes

Response parameters/data:

Octet(s)	Description	Length
1 - 16	MN-AAA Authenticator	16 bytes

The R-UIM will calculate the response as follows:

MN-AAA Authenticator = Algo (Highest Order byte from Challenge || MN-AAA SS || MIP-RRQ Hash || Least Significant bytes of Challenge up to 237 bytes)

MN-AAA SS: MN-AAA Shared Secret associated with the given NAI-Entry-Index.

Algo: The operator shall choose the function for one-way hashing. MD5 is defined as the hashing function, but the operator may choose another hashing function.

4.8.1.5 HRPD Access Authentication

This IP authentication command type generates the CHAP response used for HRPD access authentication.

COMMAND	CLASS	INS	P1	P2	Lc	Le
Compute IP Authentication	'80'	'80'	'04'	'00'	*	'10'

Command parameters/data:

Octet(s)	Description	Length
1	CHAP_ID	1 byte
2 -X	CHAP-Challenge	Lc - 1 byte

1 CHAP-ID: CHAP Identifier as specified in [23] and [26].

2 CHAP-Challenge: Challenge received from the network used in computing the CHAP-
3 Response. The length of the CHAP-Challenge depends upon the method used to generate
4 the octets, and is independent of the hash algorithm used.

5 *Lc = Length of CHAP-Challenge + 1.

6
7 Response parameters/data:

Octet(s)	Description	Length
1 - 16	CHAP-Response	16 bytes

8 The R-UIM calculates the CHAP-Response as follows:

9 CHAP-Response = Algo (CHAP-ID || CHAP-SS || CHAP-Challenge)

10 CHAP-SS: HRPD Access Authentication Shared Secret

11 Algo: The operator shall choose the function for one-way hashing. MD5 is defined as the
12 hashing function, but the operator may choose another hashing function.

13 14 **4.9 Descriptions of BCMCS Commands**

15 The following commands are used for BCMCS key management. The R-UIM shall
16 implement these commands whenever the BCMCS service is allocated in the CDMA
17 Service Table. This assumes that a BCMCS Root key is securely stored in the R-UIM.

COMMAND	CLASS	INS	P1	P2	Lc	Le
BCMCS	'A0'	'58'	P1	P2	Lc	Le

18
19
20 P1 parameter defines the BCMCS command type:

P1	CLASS
'00'	Retrieve SK
'01'	Update BAK
'02'	Delete BAK
'03'	Retrieve SRTP SK
'04'	Generate Authorization Signature
'05'	BCMCS Authentication

21
22

1 4.9.1 RETRIEVE SK

2 4.9.1.1 Command description

3 This function is used by the terminal to ask the R-UIM to calculate the BCMCS Short
 4 Term Key (SK) associated with a particular BCMCS Flow Identifier (BCMCS_Flow_ID). For
 5 this computation, the R-UIM uses the Broadcast Access Key (BAK) identified by the
 6 Broadcast Access Key Identifier (BAK_ID).

7 Input:

- 8 • Service Type = '01' corresponding to "3GPP2 BCMCS"
- 9 • BCMCS_Flow_ID
- 10 • BAK_ID
- 11 • SK_RAND

12 Output:

- 13 • SK

14 4.9.1.2 Command parameters/data:

15

Code	Value
CLA	A0
INS	'58'
P1	'00'
P2	'00'
Lc	Length of the subsequent data field
Data	Service Type, BCMCS_Flow_ID, BAK_ID, SK_RAND
Le	'12'

16 The command data contains:

- 17 -A Service Type byte: '01' ("3GPP2 BCMCS")
- 18 -Three TLV objects for BCMCS_Flow_ID, BAK_ID, SK_RAND

19 Note: Coding of Tag Field inside BCMCS TLV Objects is defined in Annex B

20 Command data:

21

Byte(s)	Description	Length
1	Service Type = '01' (3GPP2 BCMCS)	1
2-A+1	BCMCS_Flow_ID TLV	A
A+2-A+B+1	BAK_ID TLV	B
A+B+2- A+B+C+1	SK_RAND TLV	C
NOTE: The tags inside TLV objects in the command are specified in Annex B of this document.		

1 Response parameters/data:

2

Byte(s)	Description	Length
1 – 18	SK TLV	18
NOTE: The tags inside TLV objects in the response are specified in Annex B of this document.		

3

4.9.2 Update BAK

4

4.9.2.1 Command description

5

This function asks the R-UIM to perform a BCMCS BAK update.

6

Input:

7

- Service Type = '01' corresponding to "3GPP2 BCMCS"

8

- BCMCS_Flow_ID

9

- BAK_ID

10

- BAK_Expire

11

- TK_RAND

12

- Encrypted BAK

13

14

Output: None

15

4.9.2.2 Command parameters/data:

16

Code	Value
CLA	A0
INS	'58'
P1	'01'
P2	'00'
Lc	Length of the subsequent data field
Data	Service Type, BCMCS_Flow_ID, BAK_ID, BAK_Expire, TK_RAND, Encrypted BAK
Le	'00'

17

18

Command data:

Byte(s)	Description	Length
1	Service Type = '01' (3GPP2 BCMCS)	1
2-A+1	BCMCS_Flow_ID TLV	A
A+2-A+B+1	BAK_ID TLV	B
A+B+2 – A+B+C+1	BAK_Expire TLV	C
A+B+C+2 – A+B+C+D+1	TK_RAND TLV	D
A+B+C+D+2 – A+B+C+D+17	Encrypted BAK	16
NOTE: The tags inside TLV objects in the command are specified in Annex B of this document.		

1

2 Response Data: None

3

4 4.9.3 Delete BAK

5 4.9.3.1 Command description

6 This function asks the R-UIM to perform a BCMCS BAK deletion in order to free the
7 memory. This command should not be used as a means for ending a user's subscription.

8 Input:

- 9 • Service Type = '01' corresponding to "3GPP2 BCMCS"
- 10 • BCMCS_Flow_ID
- 11 • BAK_ID

12

13 Output:

14 None.

15 4.9.3.2 Command parameters/data:

16

Code	Value
CLA	A0
INS	'58'
P1	'02'
P2	'00'
Lc	Length of the subsequent data field
Data	Service Type, BCMCS_Flow_ID, BAK_ID
Le	'00'

17

18 Command data:

Byte(s)	Description	Length
1	Service Type = '01' (3GPP2 BCMCS)	1
2-A+1	BCMCS_Flow_ID TLV	A
A+2-A+B+1	BAK_ID TLV	B
NOTE: The tags inside TLV objects in the command is specified in Annex B of this document.		

1

2 Response Data: None

3 The following diagnostics shall be indicated in the command response by the following
4 Status Words:

5 '9402': Invalid BAK ID.

6 '9404': Invalid BCMCS Flow ID.

7

8 4.9.4 RETRIEVE SRTP SK

9 4.9.4.1 Command description

10 This function is used by the terminal to ask the R-UIM to calculate the BCMCS SRTP
11 Short Term Key (SK) associated with a particular BCMCS Flow Identifier (BCMCS_Flow_ID).
12 For this computation, the R-UIM uses the Broadcast Access Key (BAK) identified by the
13 *BCMCS_Flow_ID*, Broadcast Access Key Identifier (BAK_ID), SK_RAND and Packet Index.

14 Input:

- 15 • Service Type = '01' corresponding to "3GPP2 BCMCS"
- 16 • *BCMCS_Flow_ID*
- 17 • BAK_ID
- 18 • SK_RAND
- 19 • Packet Index

20 Output:

- 21 • SRTP SK

4.9.4.2 Command parameters/data:

Code	Value
CLA	A0
INS	'58'
P1	'03'
P2	'00'
Lc	Length of the subsequent data field
Data	Service Type, <i>BCMCS_Flow_ID</i> , BAK_ID, SK_RAND, Packet Index
Le	'12'

The command data contains:

-Three TLV objects for BAK_ID, SK_RAND and Packet Index

Command data:

Byte(s)	Description	Length
1	Service Type = '01' (3GPP2 BCMCS)	1
2 - A+1	<i>BAK</i> <i>BCMCS_Flow_ID</i> TLV	A
A+2 - A+B+1	<i>SK_RAND</i> <i>BAK_ID</i> TLV	B
A+B+2- A+B+C+1	<i>Packet Index</i> <i>SK_RAND</i> TLV	C
<i>A+B+C+2- A+B+C+D+1</i>	<i>Packet Index</i> TLV	D
NOTE: The tags inside TLV objects in the command are specified in Annex B of this document.		

Response parameters/data

Byte(s)	Description	Length
1 - 18	SRTP SK TLV	18
NOTE: The tag inside TLV object in the response is specified in Annex B of this document.		

4.9.5 Generate Authorization Signature

4.9.5.1 Command description

This function is used by the terminal to ask the R-UIM to calculate the authorization signature associated with a particular BCMCS Flow Identifier (BCMCS_Flow_ID). For this computation, the R-UIM uses the Broadcast Access Key (BAK) identified by the Broadcast Access Key Identifier (BAK_ID) and timestamp.

1 Input:

- 2 • Service Type
- 3 • BCMCS_Flow_ID
- 4 • BAK_ID
- 5 • Timestamp

7 Output:

- 8 • Auth Signature

9 4.9.5.2 Command parameters/data:

Code	Value
CLA	A0
INS	'58'
P1	'04'
P2	'00'
Lc	Length of the subsequent data field
Data	Service Type, BCMCS_Flow_ID, BAK_ID, Timestamp
Le	'06'

11 The command data contains:

- 12 -Three TLV objects for BCMCS_Flow_ID, BAK_ID, and Timestamp.

14 Command data:

Byte(s)	Description	Length
1	Service Type = '01' (3GPP2 BCMCS)	1
2-A+1	BCMCS_Flow_ID TLV	A
A+2-A+B+1	BAK_ID TLV	B
A+B+2-A+B+C+1	Timestamp TLV	C
NOTE: The tags inside TLV objects in the command are specified in Annex B of this document.		

17 Response parameters/data

Byte(s)	Description	Length
1 – 6	Auth Signature TLV	6
NOTE: The tag inside TLV object in the response is specified in Annex B of this document.		

1
2
3
4
5
6
7
8
9
10
11
12
13
14
15
16
17
18
19
20
21
22

4.9.6 BCMCS Authentication

4.9.6.1 Command description

This function is used by the terminal to ask the R-UIM to calculate the BCMCS digest response for information acquisition. For this computation, the R-UIM uses the BCMCS Root Key.

Input:

- RAND
- Challenge

Output:

- Digest Response

4.9.6.2 Command parameters/data:

Code	Value
CLA	A0
INS	'58'
P1	'05'
P2	'00'
Lc	Length of the subsequent data field
Data	RAND, Challenge
Le	'12'

The command data contains:

- Two TLV objects for RAND, and Challenge.

Command data:

Byte(s)	Description	Length
1	Service Type = '01' (3GPP2 BCMCS)	1
2-A+1	RAND TLV	A
A+2-A+B+1	Challenge TLV	B
NOTE: The tags inside TLV objects in the command are specified in Annex B of this document.		

Response parameters/data

Byte(s)	Description	Length
1 - 18	Digest Response TLV	18
NOTE: The tag inside TLV object in the response is specified in Annex B of this document.		

4.10 Descriptions of Application Authentication Commands

The ME will select the authentication mechanism based on the capability of the R-UIM card and the server, and send an Authenticate Command to the card to generate the response and optionally session keys. Successful authentication calculation will cause SW1 to be set to '90' and SW2 to be set to '00'. Unsuccessful calculation will cause SW1 to be set to '98' and SW2 to be set to '04'.

For complete details on MMS, refer to [37], [39], [40] and [41]. For complete details on MMD, refer to [45]

4.10.1 Application Authentication Command

R-UIM generates response and optional 1 or 2 sets of session keys.

COMMAND	CLASS	INS	P1	P2	Lc	Le
Application Authentication	'A0'	'5A'	'00'	'00'	'xx'	'xx'

Command parameters/data:

Octet(s)	Description	Length
1	Authentication Mechanism & Algorithm	1 byte
2	Application ID	1 byte
3-4	Length of Realm (Service or Host Name)	2 bytes
5 to A+4	Realm (Service or Host Name)	A bytes
A +5 to A+6	Length of Server Nonce	2 bytes
A +7 to A + B+6	Server Nonce	B bytes
A+ B+7 to A + B +8	Length of Client Nonce	2 bytes
A + B+9 to A+B+C+8	Client Nonce	C bytes

The coding for authentication mechanism & algorithm is defined according to the following table:

Table 0-1 Authentication mechanism

Binary Value	Authentication Mechanism
'00000000'	CRAM-MD5
'00000001'	HTTP Digest (MD5)
'00000010'	HTTP Digest (MD5-sess)
'00000011'	HTTP Digest (AKAv1-MD5)

'00000100'	HTTP Digest (AKAv1-MD5-sess)
'00000101'	SASL DIGEST
'00000110'	SASL OTP
'00000111'	SASL GSSAPI
'00001000'-'11111111'	Reserved

1

2 Response parameters/data:

Octet(s)	Description	Length
1	Response Length	1 bytes
2 to X+1	Response	X bytes
X+2 to X+ 3	SessionKey1 Length	2 bytes
X+ 4 to X+ Y+3	SessionKey1	Ybytes
X+ Y+4 to X+ Y+5	SessionKey2 Length	2 bytes
X+ Y+6 to X+ Y+ Z+5	SessionKey2	Z bytes

3 It is up to different authentication mechanism algorithm to determine if session keys are
 4 needed and if so, how many session keys should be returned. For example, SASL Digest
 5 returns 2 session keys, HTTP Digest (MD5-session) returns 1 session key and HTTP Digest
 6 (MD5) returns no session key. If no session key is to be returned by the R-UIM, the R-UIM
 7 shall set the corresponding session key length to 0.

8 The following is a call flow for MMS message retrieval:

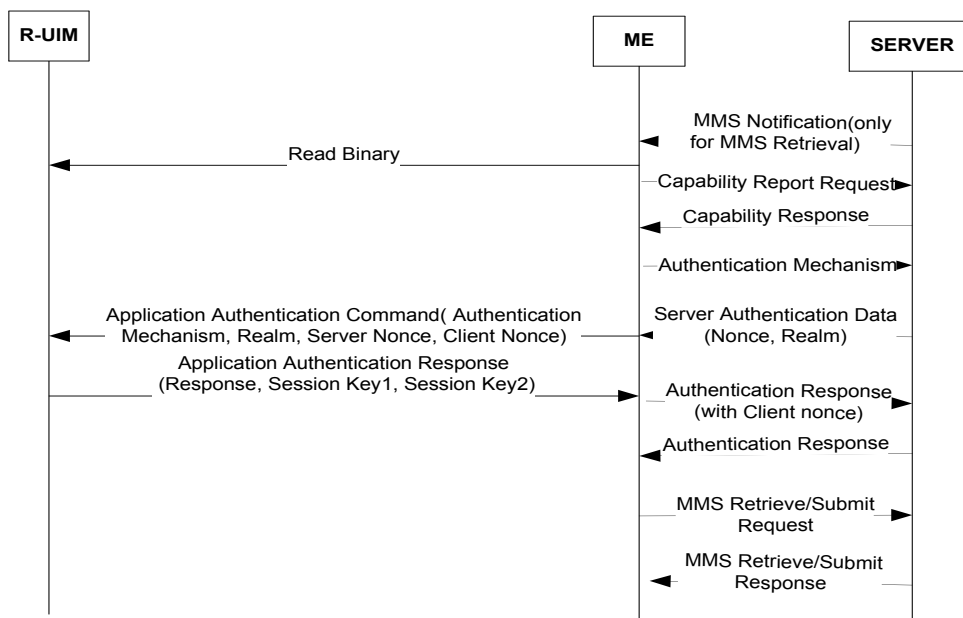

Note:
 Capability Report/Response/Authentication Mechanism are all optional; that is, either none of them are used, or all of them are used. The carrier determines to use them or not.

4.11 Description of AKA-related Functions

In order to support AKA, the R-UIM shall support the requirement defined in Section 2.2.2 of [42]. The following AKA-related parameters are stored in the R-UIM.

- Root Key
- Cipher and Integrity Keys (CK, IK)
- SQN_{MS}
- UAK (if supported)

4.11.1 Authentication and key agreement procedure

This section gives an overview of the authentication mechanism and cipher and integrity key generation that are invoked by the network. For complete details, refer to [5], [20] and [42]. The mechanism achieves mutual authentication by the user and the network showing knowledge of a secret root key that is shared between the R-UIM and the Authentication Center. In addition, the R-UIM keeps track of a counter SQN_{MS} to support network authentication. SQN_{MS} denotes the highest sequence number the R-UIM has ever accepted.

The R-UIM first computes the anonymity key $AK = f_5(RANDA)$ and retrieves the $SQN = (SQN \oplus AK) \oplus AK$

Then the R-UIM computes $MACA = f_1(SQN || RAND || AMF)$ as defined in [20]. This value is compared with the MAC-A value included in AUTN.

The R-UIM keeps track of a counter SQN_{MS} to support network authentication. SQN_{MS} denotes the highest sequence number the R-UIM has ever accepted. If the R-UIM detects the sequence numbers to be invalid, the R-UIM shall set synchronization failure tag to '00000001' and include AUTS.

Where $AUTS = ConSeq(SQN_{MS}) || MACS$;

$ConSeq(SQN_{MS}) = SQN_{MS} \oplus f_5^*(RAND)$ is the concealed value of the counter SQN_{MS} in the R-UIM and $MACS = f_1^*(SQN_{MS} || RAND || AMF)$;

27

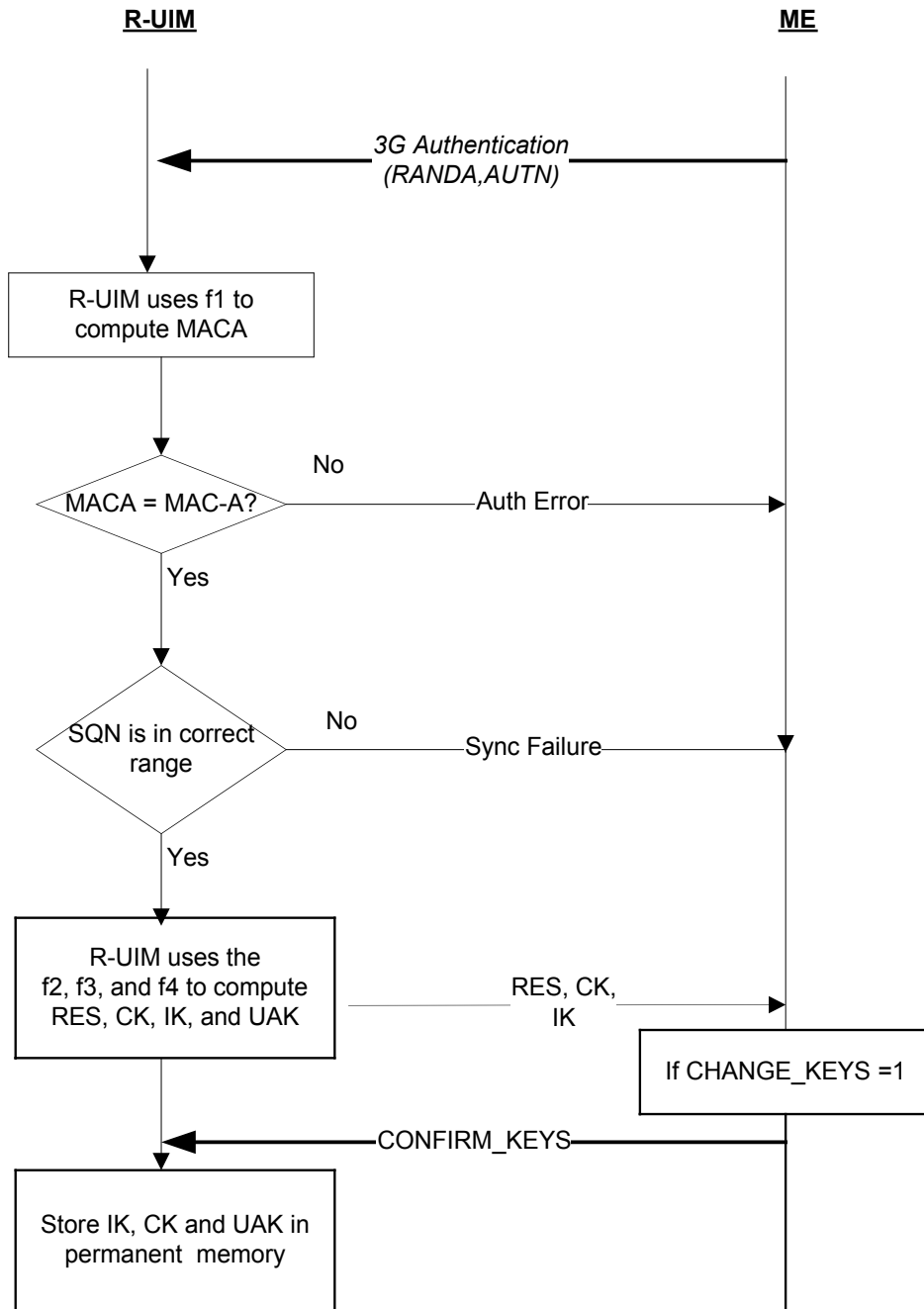

1
2
3

Figure 4.11.1-1 AKA Procedures

1 4.11.2 Cryptographic Functions

2 The names and parameters of the cryptographic functions supported by the R-UIM are
3 defined in [42].

4 4.11.3 3G Authentication Command description

5 The function is used during the procedure for authenticating the R-UIM to its network
6 and vice versa. In addition, a cipher key, an integrity key, and UAK if supported, are
7 calculated. For the execution of the command the R-UIM uses the root key, which is
8 stored in the R-UIM.

10 4.11.4 UMAC Generation Command Description

11 If UAK is supported by the R-UIM, the R-UIM uses UAK to convert MAC-I, into UMAC. If
12 UMAC is successfully generated, the R-UIM responds to the ME by setting the Success Tag
13 to '1' and including the UMAC in the response to the ME. Otherwise, the R-UIM sets the
14 Success Tag to '0' and omits the UMAC.

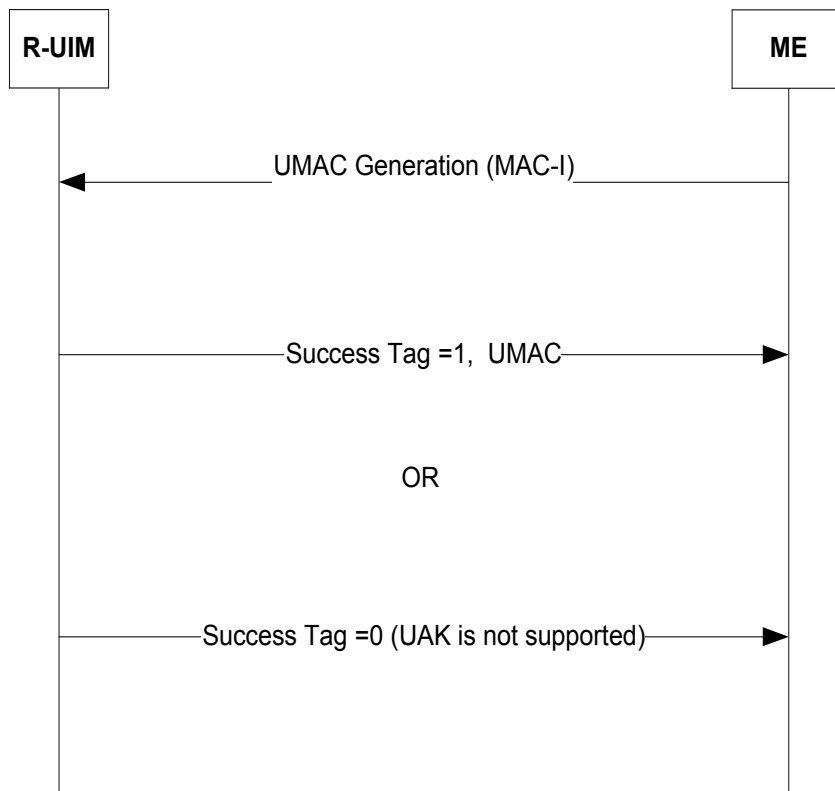

16 **Figure 4.11.4-1 UMAC Generation**

4.11.5 Restoration of 3G keys

The CK and IK are generated during AKA, and updated through AKA. The CK and IK are stored in the R-UIM and a copy is stored in the ME. The CK and IK are sent from the R-UIM to the ME upon request from the ME. The ME shall delete the CK and IK from memory after power-off as well as after removal of the R-UIM. Upon powering on, the ME shall check the R-UIM revision and service table, if AKA is supported and activated, then the ME shall read the EF_{3GCIK} from the R-UIM and restore them.

4.11.6 CONFIRM_KEYS Command description

The function is used during the procedure for 3G authentication. The (IK, CK) pair and the UAK that was calculated by the R-UIM when it received the 3G Authentication command is now stored in permanent memory.

4.12 Description of AKA commands

4.12.1 UMAC Generation

COMMAND	CLASS	INS	P1	P2	Lc	Le
UMAC Generation	'A0'	'5E'	'00'	'00'	'04'	'xx'

Command parameters/data:

Octet(s)	Description	Length
1-4	MAC-I	4 bytes

Response parameters/data:

Octet(s)	Description	Length
1	SUCCESS TAG	1 byte
2 – 5	UMAC	0 or 4 bytes

If the R-UIM generates UMAC successfully, the R-UIM shall set success tag to '00000001', and include the UMAC. If the R-UIM does not support UAK, the R-UIM shall set success tag to '00000000' and omit the UMAC. All the other values are reserved.

4.12.2 CONFIRM_KEYS

COMMAND	CLASS	INS	P1	P2	Lc	Le
CONFIRM_KEYS	'A0'	'5C'	'00'	'00'	empty	empty

Command parameters/data:

The command has no parameters

Response parameters/data:

No response parameters are generated as a result of this command.

1 **5 ADDITIONAL AIR INTERFACE PROCEDURES**

2 **5.1 Registration Procedure**

3 5.1.1 R-UIM Removal and Insertion

4 Upon the removal of an R-UIM from a powered-on ME, the ME shall clear its temporary
5 memory of R-UIM related parameters.

6 Upon the insertion of an R-UIM into a powered-on ME, the ME shall perform the following:

- 7 • Perform ME/R-UIM initialization tasks;
- 8 • Update its NAM parameters to those stored on the R-UIM; for any service
9 available and activated in the R-UIM, the parameters available from the R-UIM
10 shall be used.
- 11 • Perform the actions defined in 6.6.5.5.1.1. of [14] or 2.6.5.5.1.1. of [5]; and
- 12 • Enter the System *Determination Substate* with a power-up indication as
13 described in [5] or [14].

14 5.1.2 Procedure when ESN Changes with TMSI Assigned

15 When the ME detects that an R-UIM is inserted, it will use the Store ESN_MEID_ME
16 command to inform the R-UIM of the ESN or MEID of the ME. If bit 0 of octet 1 of the
17 response parameters/data to the Store ESN_MEID_ME command is set to '1',
18 REG_ENABLED_s is equal to YES and there is a TMSI assigned in the R-UIM (the bits of the
19 TMSI_CODE_{s-p} field of the TMSI EF are not all set to '1'), the ME shall perform the
20 following:

- 21 • Store the value USE_TMSI_s in a temporary variable;
- 22 • Set USE_TMSI_s to '0';
- 23 • Initiate a power up registration regardless of the state of POWER_UP_REG_s and
24 REGISTERED_s; and
- 25 • Restore the value of USE_TMSI_s from the temporary variable.

26 If the registration fails due to access attempt failure or if the registration is cancelled due
27 to initiation of an origination by the user or detection of a page match (see section 6.6.3.6
28 of [14] and section 2.6.3.6 of [5]), the ME shall delete the TMSI in the R-UIM by setting all
29 bits of the TMSI_CODE_{s-p} field of the TMSI EF to '1'.

30 **5.2 NAM Parameters when no R-UIM is inserted into the ME**

31 When no R-UIM is inserted into the ME, the ME shall use the following default set of NAM
32 parameters, from Section 3.1 of [7]:

- 33 • IMSI_M_CLASS_p shall be set to 0.

- 1 • MCC_{Mp}, IMSI_{M_11_12p}, and IMSI_{M_Sp} shall be set to coded value of the IMSI_M
2 with the four least-significant digits set to ESN_p, converted directly from binary to
3 decimal, modulo 10000. The other digits shall be set to 0.
- 4 • IMSI_{M_ADDR_NUMp} shall be set to '000'.
- 5 • IMSI_{T_CLASSp} shall be set to 0.
- 6 • MCC_{Tp}, IMSI_{T_11_12p}, and IMSI_{T_Sp} shall be set to the coded value of the
7 IMSI_T with the four least-significant digits set to ESN_p, converted directly from
8 binary to decimal, modulo 10000. The other digits shall be set to 0.
- 9 • IMSI_{T_ADDR_NUMp} shall be set to '000'.
- 10 • ACCOLC_p shall be set as specified in 6.3.5 of [14].
- 11 • HOME_SID_p, if present, shall be set to 0.
- 12 • All other indicators of the selected NAM may be set to manufacturer-defined default
13 values. All configuration indicator values shall be set within their valid range (see
14 F.3 of [14]).

15 MEs may perform any function allowable by applicable standards, including system
16 accesses when no R-UIM is inserted into the ME.

17

18 **5.3 IMSI-Related Parameters in the ME when no IMSI is Programmed in the R-UIM**

19 When the IMSI_{M_PROGRAMMED} bit of the IMSI_M EF is set to '0', the ME shall use the
20 following values associated with IMSI_M in lieu of the values programmed in the IMSI_M
21 EF:

- 22 • IMSI_{M_CLASSp} shall be set to 0.
- 23 • MCC_{Mp}, IMSI_{M_11_12p}, and IMSI_{M_Sp} shall be set to the coded value of the
24 IMSI_M with the four least-significant digits set to ESN_p, converted directly from
25 binary to decimal, modulo 10000. The other digits shall be set to 0.
- 26 • IMSI_{M_ADDR_NUMp} shall be set to '000'.
- 27 • ACCOLC_p shall be set as specified in 6.3.5 of [14].

28 When the IMSI_{T_PROGRAMMED} bit of the IMSI_T EF is set to '0', the ME shall use the
29 following values for IMSI_T in lieu of the values programmed in the IMSI_T EF:

- 30 • IMSI_{T_CLASSp} shall be set to 0.
- 31 • MCC_{Tp}, IMSI_{T_11_12p}, and IMSI_{T_Sp} shall be set to the coded value of the
32 IMSI_T with the four least-significant digits set to ESN_p, converted directly from
33 binary to decimal, modulo 10000. The other digits shall be set to 0.
- 34 • IMSI_{T_ADDR_NUMp} shall be set to '000'.

35

1 **5.4 Preferred Access Channel Mobile Station ID Type**

2 Operational Requirement:

3 If UIMID Usage Indicator='0' or SF_EUIMID Usage Indicator = '0' (service n8 is allocated and
4 activated, bit 1 or 2 of EF_{USGIND} to '0'), appropriate PREF_MSID value should be set in
5 overhead message.

6

7

- 1 No text.

1 **6 BCMCS PROCEDURES**

2 For complete details, refer to [36].

3 **6.1 Functionalities of R-UIM and ME**

4 6.1.1 R-UIM

- 5 • Generate TK from BCMCS Root Key and TK_RAND, then decrypt BAK using TK
- 6 • Compute SK from BAK and SK_RAND and pass SK to ME
- 7 • Store BCMCS Root Key, BAK, BCMCS_Flow_ID, BAK_ID and BAK_Expire
- 8 • When necessary, generate Auth-Key from BCMCS Root Key and calculate digest
- 9 response
- 10 • When necessary, generate SRTP session Encryption Key using AES
- 11 • Generate authorization signature from BAK and timestamp by using EHMAC
- 12 algorithm (BAK Hash)

13 6.1.2 ME

- 14 • Use SK to decrypt BCMCS content
- 15 • Determine whether to issue RetrieveSK command by checking BAK_ID and
- 16 SK_RAND
- 17 • Initiate BAK Request to the network and issue update BAK command
- 18 • Can store BCMCS_FLOW_ID, BAK_ID, BAK_EXPIRE, SK and SK_RAND
- 19 • Determine the expiration status of BAK and send delete BAK command when
- 20 necessary

22 **6.2 Key Management**

23 If service n^{039} is allocated, a secret list of current BAK values (BAK) and secret list of
 24 updated BAK values (UpdatedBAK) shall be securely maintained in the R-UIM (not
 25 accessible to the ME). When ME sends a Update BAK command, the R-UIM shall create a
 26 new entry in $EF_{UpBAKPARA}$ and put the decrypted BAK into a record in the secret list of
 27 updated BAK values (UpdatedBAK) corresponding to $EF_{UpBAKPARA}$.

28 When ME sends a Delete BAK command, the R-UIM shall search for the given
 29 (BCMCS_Flow_ID, BAK_ID) pair in $EF_{BAKPARA}$. If such a record is found, it shall erase (fill up
 30 with 'FF') the record corresponding to the BAK in the BAK secret list (BAK). If this search is
 31 unsuccessful, the R-UIM shall look for the (BCMCS_Flow_ID, BAK_ID) pair in $EF_{UpBAKPARA}$. If
 32 the record is found, the R-UIM shall remove the record in $EF_{UpBAKPARA}$ and corresponding

1 BAK in the Updated BAK secret list (UpdatedBAK) identified by BCMCS_Flow_ID and
2 BAK_ID.

3 When ME sends a Retrieve SK command, if BCMCS_Flow_ID and BAK_ID are found in
4 $EF_{BAKPARA}$, R-UIM shall use the corresponding BAK from the secret BAK list (BAK) to
5 generate SK. Otherwise, if the ID pair matches any record in $EF_{UpBAKPARA}$, R-UIM shall copy
6 the 3 parameters (BCMCS_Flow_ID, BAK_ID, BAK_Expire) into the $EF_{BAKPARA}$, copy the
7 corresponding BAK from the Updated BAK secret list (UpdatedBAK) to the BAK secret list
8 (BAK) and use this BAK to generate SK. If none of the precedent procedures apply
9 (BCMCS_Flow_ID and BAK_ID unavailable), the R-UIM shall reply with an appropriate error
10 status word '6A88', "referenced data not found".

1 **ANNEX A (INFORMATIVE): SUGGESTED CONTENTS OF THE EFS AT PRE-PERSONALIZATION**

2
3 Table A-1 is a general outline of the R-UIM files defined in this specification.

- 4 1. All values are sized in Bytes unless otherwise noted.
- 5 2. Default Values are specified when available and are intended to be guidelines only. In some cases, operators must specify
6 explicit parameter values as no logical default exists. In the case where the parameter values are necessary, valid values
7 and/or ranges are listed.
- 8 3. Default and Parameter values are for general quick reference only and not intended to specify details. Refer to the
9 corresponding file for details.
- 10 4. Default Values and Parameter Values are specified in Hexadecimal, unless otherwise noted.
- 11 5. GSM-specific files are not included.
- 12 6. If EFs have an unassigned value, it may not be clear from the main text what this value should be. This annex suggests
13 values in these cases.
- 14
15

Table A-1. Summary of R-UIM Files

<i>File Name</i>	<i>File ID</i>	<i>File Type</i>	<i>Access - Read</i>	<i>Access - Update</i>	<i>Access - Invalidate-Rehabilitate</i>	<i>Size in Bytes</i>	<i>Mandatory or Optional</i>	<i>Default Values (D) and/or Parameter Values (P) in Bytes</i>
Authentication – NAM Parameters and Operational Parameters								
A-Key	-	-	Never	Never	-	8	M	Specified by Operator
Root Key	-	-	Never	Never	-	16	M	Specified by Operator
BCMCS Root Key	-	-	Never	Never	-	16	O	Specified by Operator
IMS Root Key	-	-	Never	Never	-	16	O	Specified by Operator

File Name	File ID	File Type	Access - Read	Access - Update	Access - Invalidate-Rehabilitate	Size in Bytes	Mandatory or Optional	Default Values (D) and/or Parameter Values (P) in Bytes
WLAN Root Key	-	-	Never	Never	-	16	O	Specified by Operator
SSD	-	-	Never	Never	-	16	M	-
EF _{COUNT}	3F00/7F25/6F21	CY	CHV1	CHV1	ADM-ADM	2	M	D = '00 00'
BAK	-	-	Never	Never	-	16	O	Specified by Operator
UpdatedBAK	-	-	Never	Never	-	16	O	Specified by Operator
SharedSecret	-	-	Never	Never	-	Variable	O	Specified by Operator
UAK	-	-	Never	Never	-	16	O	Specified by Operator
SQN _{MS}	-	-	Never	Never	-	6	O	-
NAM Parameters and Operational Parameters								
EF _{IMSI_M}	3F00/7F25/6F22	TR	CHV1	ADM	ADM-CHV1	10	M	P = Specified by Operator or D='00...00'
EF _{IMSI_T}	3F00/7F25/6F23	TR	CHV1	ADM	ADM-CHV1	10	M	P = Specified by Operator or D='00...00'
EF _{TMSI}	3F00/7F25/6F24	TR	CHV1	CHV1	ADM-CHV1	16	M	D = '00 00 00 00 00 00 00 00 00 00 FF FF FF FF 00 00 00'
EF _{AH}	3F00/7F25/6F25	TR	CHV1	CHV1	ADM-ADM	2	M	P = Specified by Operator or D = '00 00'
EF _{AOP}	3F00/7F25/6F26	TR	CHV1	CHV1	ADM-ADM	1	M	-
EF _{ALOC}	3F00/7F25/6F27	TR	CHV1	CHV1	ADM-ADM	7	M	-
EF _{CDMAHOME}	3F00/7F25/6F28	LF	CHV1	CHV1	ADM-ADM	5	M	P = Specified by Operator or D = '00 00 00 00 00'

File Name	File ID	File Type	Access - Read	Access - Update	Access - Invalidate-Rehabilitate	Size in Bytes	Mandatory or Optional	Default Values (D) and/or Parameter Values (P) in Bytes
EF _{ZNREGI}	3F00/7F25/6F29	LF	CHV1	CHV1	ADM-ADM	8	M	D = '00 00 00 00 00 00 00 00'
EF _{SNREGI}	3F00/7F25/6F2A	TR	CHV1	CHV1	ADM-ADM	7	M	-
EF _{DISTRREGI}	3F00/7F25/6F2B	TR	CHV1	CHV1	ADM-ADM	8	M	D = '00 00 00 00 00 00 00 00'
EF _{ACCOLC}	3F00/7F25/6F2C	TR	CHV1	ADM	ADM-ADM	1	M	P = '00' to '0F' derived from IMSI_M / IMSI_T
EF _{TERM}	3F00/7F25/6F2D	TR	CHV1	CHV1	ADM-ADM	1	M	Specified by Operator P = '00' to '07'
EF _{SSCI}	3F00/7F25/6F2E	TR	CHV1	CHV1	ADM-ADM	1	O	Specified by Operator P = '00' to '07'
EF _{ACP}	3F00/7F25/6F2F	TR	CHV1	CHV1	ADM-ADM	7	M	Specified by Operator
EF _{PRL}	3F00/7F25/6F30	TR	CHV1	ADM	ADM-ADM	Variable	M	Specified by Operator
EF _{RUIMID}	3F00/7F25/6F31	TR	ALW	NEVER	NEVER-NEVER	8	M	Specified by R-UIM Manufacturer
EF _{CST}	3F00/7F25/6F32	TR	CHV1	ADM	ADM-ADM	Variable	M	Specified by Operator
EF _{SPC}	3F00/7F25/6F33	TR	ADM	ADM	ADM-ADM	3	M	D = '00 00 00' or P = '00 00 00' to '99 99 99'
EF _{OTAPASPC}	3F00/7F25/6F34	TR	CHV1	CHV1	ADM-ADM	1	M	Specified by Operator or D = '00'
EF _{NAMLOCK}	3F00/7F25/6F35	TR	CHV1	CHV1	ADM-ADM	1	M	Specified by Operator
EF _{OTA}	3F00/7F25/6F36	TR	CHV1	ADM	ADM-ADM	Variable	M	P = Defined in [7]
EF _{SP}	3F00/7F25/6F37	TR	CHV1	CHV1	ADM-ADM	1	M	Specified by Operator
EF _{ESNME}	3F00/7F25/6F38	TR	ALW	ADM	ADM-ADM	8	M	D = '00...00'

File Name	File ID	File Type	Access - Read	Access - Update	Access - Invalidate-Rehabilitate	Size in Bytes	Mandatory or Optional	Default Values (D) and/or Parameter Values (P) in Bytes
EF _{Revision}	3F00/7F25/6F39	TR	ALW	ADM	ADM-ADM	1	M	D = '03'
EF _{PL}	3F00/7F25/6F3A	TR	ALW	CHV1	ADM-ADM	Variable	M	D = 'FF... FF'
EF _{SMS}	3F00/7F25/6F3C	LF	CHV1	CHV1	ADM-ADM	Variable	O	D = '00 FF...FF'
EF _{SMSp}	3F00/7F25/6F3D	LF	CHV1	CHV1	ADM-ADM	Variable	O	D = 'FF...FF'
EF _{SMSs}	3F00/7F25/6F3E	TR	CHV1	CHV1	ADM-ADM	Variable	O	D = 'FF...FF'
EF _{SSFC}	3F00/7F25/6F3F	TR	CHV1	CHV1	ADM-ADM	Variable	O	Specified by Operator
EF _{SPN}	3F00/7F25/6F41	TR	ALW	ADM	ADM-ADM	35	O	Specified by Operator
EF _{USGIND}	3F00/7F25/6F42	TR	CHV1	ADM	ADM-ADM	1	M	Specified by Operator
EF _{AD}	3F00/7F25/6F43	TR	ALW	ADM	ADM-ADM	Variable	M	D = '00...00'
EF _{MDN}	3F00/7F25/6F44	LF	CHV1	CHV1	ADM-ADM	11	O	Specified by Operator
EF _{MAXPRL}	3F00/7F25/6F45	TR	CHV1	ADM	ADM-ADM	2 or 4	M	Specified by Operator
EF _{SPCS}	3F00/7F25/6F46	TR	CHV1	NEVER	NEVER-NEVER	1	M	P = If EF 6F33 is set to default value then D = '00' otherwise D = '01'
EF _{ECC}	3F00/7F25/6F47	TR	ALW	ADM	ADM-ADM	Variable	O	D = 'FF'
EF _{ME3GPDOPC}	3F00/7F25/6F48	TR	CHV1	CHV1	ADM-ADM	1	O	D = '00'
EF _{3GPDOPM}	3F00/7F25/6F49	TR	CHV1	CHV1	ADM-ADM	1	O	Specified by Operator
EF _{SIPCAP}	3F00/7F25/6F4A	TR	CHV1	ADM	ADM-ADM	4	O	Specified by Operator
EF _{MIPCAP}	3F00/7F25/6F4B	TR	CHV1	ADM	ADM-ADM	5	O	Specified by Operator
EF _{SIPUPP}	3F00/7F25/6F4C	TR	CHV1	ADM	ADM-ADM	Variable	O	Specified by Operator
EF _{MIPUPP}	3F00/7F25/6F4D	TR	CHV1	ADM	ADM-ADM	Variable	O	Specified by Operator

File Name	File ID	File Type	Access - Read	Access - Update	Access - Invalidate-Rehabilitate	Size in Bytes	Mandatory or Optional	Default Values (D) and/or Parameter Values (P) in Bytes
EF _{SIPSP}	3F00/7F25/6F4E	TR	CHV1	CHV1	ADM-ADM	1	O	Specified by Operator
EF _{MIFSP}	3F00/7F25/6F4F	TR	CHV1	CHV1	ADM-ADM	Variable	O	Specified by Operator
EF _{SIPPAPSS}	3F00/7F25/6F50	TR	CHV1	CHV1	ADM-ADM	Variable	O	Specified by Operator
SimpleIP CHAP SS	-	-	Never	Never	-	Variable	O	Specified by Operator
MobileIP SS	-	-	Never	Never	-	Variable	O	Specified by Operator
Shared Secret	-	-	Never	Never	-	Variable	O	Specified by Operator
EF _{PUZL}	3F00/7F25/6F53	TR	CHV1	ADM	ADM-ADM	Variable	O	Specified by Operator
EF _{MAXPUZL}	3F00/7F25/6F54	TR	CHV1	ADM	ADM-ADM	5	O	Specified by Operator
EF _{MECRP}	3F00/7F25/6F55	TR	CHV1	CHV1	ADM-ADM	3	M	D = '00 00 00'
EF _{HRPDCAP}	3F00/7F25/6F56	TR	CHV1	ADM	ADM-ADM	2	O	Specified by Operator
EF _{HRPDUPP}	3F00/7F25/6F57	TR	CHV1	ADM	ADM-ADM	Variable	O	Specified by Operator
HRPD AA CHAP SS	-	-	Never	Never	-	Variable	O	Specified by Operator
EF _{CSSPR}	3F00/7F25/6F58	TR	CHV1	ADM	ADM-ADM	1	O	D = 'FF'
EF _{ATC}	3F00/7F25/6F59	TR	CHV1	ADM	ADM-ADM	1	O	Specified by Operator
EF _{EPRL}	3F00/7F25/6F5A	TR	CHV1	ADM	ADM-ADM	Variable	O	Specified by Operator
EF _{BCSMScfg}	3F00/7F25/6F5B	TR	CHV1	ADM	ADM-ADM	1	O	Specified by Operator
EF _{BCSMSpref}	3F00/7F25/6F5C	TR	CHV1	CHV1	ADM-ADM	1	O	D = 'FF'
EF _{BCSMStable}	3F00/7F25/6F5D	LF	CHV1	ADM	ADM-ADM	Variable	O	D = '00 FF...FF'
EF _{BCSMSp}	3F00/7F25/6F5E	LF	CHV1	CHV1	ADM-ADM	2	O	D = 'FF FF'
EF _{IMPI}	3F00/7F25/6F5F	TR	CHV1	ADM	ADM-ADM	Variable	O	Specified by Operator

File Name	File ID	File Type	Access - Read	Access - Update	Access - Invalidate-Rehabilitate	Size in Bytes	Mandatory or Optional	Default Values (D) and/or Parameter Values (P) in Bytes
EF _{DOMAIN}	3F00/7F25/6F60	TR	CHV1	ADM	ADM-ADM	Variable	O	Specified by Operator
EF _{IMPU}	3F00/7F25/6F61	LF	CHV1	ADM	ADM-ADM	Variable	O	Specified by Operator
EF _{PCSCF}	3F00/7F25/6F62	LF	CHV1	ADM	ADM-ADM	Variable	O	Specified by Operator
EF _{BAKPARA}	3F00/7F25/6F63	LF	CHV1	ADM	ADM-ADM	Variable	O	Specified by Operator
EF _{UpBAKPARA}	3F00/7F25/6F64	CY	CHV1	ADM	ADM-ADM	Variable	O	Specified by Operator
EF _{MMSN}	3F00/7F25/6F65	LF	CHV1	CHV1	ADM-ADM	Variable	O	D='00 00 00 FF...FF'
EF _{EXTS}	3F00/7F25/6F66	LF	CHV1	CHV1	ADM-ADM	Variable	O	D='FF...FF'
EF _{MMSICP}	3F00/7F25/6F67	TR	CHV1	ADM	ADM-ADM	Variable	O	D='FF...FF'
EF _{MMSUP}	3F00/7F25/6F68	LF	CHV1	CHV1	ADM-ADM	Variable	O	D='FF...FF'
EF _{MMSUCP}	3F00/7F25/6F69	TR	CHV1	CHV1/2	ADM-ADM	Variable	O	D= 'FF...FF'
EF _{AuthCapability}	3F00/7F25/6F6A	LF	CHV1	ADM	ADM-ADM	Variable	O	D= '00...00'
EF _{3GCIK}	3F00/7F25/6F6B	TR	CHV1	ADM	ADM-ADM	32	O	Specified by Operator
EF _{DCK}	3F00/7F25/6F6C	TR	CHV1	CHV1	ADM-ADM	20	O	Specified by Operator
EF _{GID1}	3F00/7F25/6F6D	TR	CHV1	ADM	ADM-ADM	N	O	Specified by Operator
EF _{GID2}	3F00/7F25/6F6E	TR	CHV1	ADM	ADM-ADM	N	O	Specified by Operator
EF _{CDMACNL}	3F00/7F25/6F6F	TR	CHV1	ADM	ADM-ADM	7N	O	Specified by Operator
EF _{SF_EUIMID}	3F00/7F25/6F74	TR	ALW	NEVER	NEVER-NEVER	7	O	Specified by R-UIM Manufacturer

ANNEX B (INFORMATIVE): BCMCS-RELATED TAG VALUES

Tag	Name of Data Element	Usage
'80'	BCMCS Flow ID TLV object	BCMCS command
'81'	BAK ID TLV object	BCMCS command
'82'	RAND, SK RAND or TK RAND TLV objects	BCMCS command
'83'	BAK Expire TLV object	BCMCS command
'84'	Packet Index TLV object	BCMCS command
'85'	SK TLV object or SRTP SK TLV object	BCMCS command
'86'	Timestamp TLV object	BCMCS command
'87'	Auth Signature TLV object	BCMCS command
'88'	Challenge TLV object	BCMCS command
'89'	Digest Response TLV object	BCMCS command